



Product Catalog

Grace
COMPANY



Grace Bagley was working at a local quilt shop, Mormon Handicraft, where she witnessed first-hand the needs of the quilting industry.

During a conversation with her son, Jim, she expressed these wants and wishes, not knowing that these simple comments would spark the invention of a better quilting frame and the founding of a company. Jim held onto the idea, and his creative wheels began to spin. Soon, through impressive ingenuity and workmanship, Jim was manufacturing a frame of his own invention, a quilting frame with a no-baste rail system fittingly named the GraceFrame.

Mormon Handicraft became the first store to display and sell the GraceFrame. The frame sold very well, and Jim began making frequent deliveries of the product

to the store. In 1987, Jim and his wife Lori, with their infant child Bonnie, ventured off for the first time to International Quilt Festival in Houston, Texas. This immediately broadened the frame's exposure and expanded business for the Grace Company, helping it become a national, rather than just a local success.

It wasn't long before the ever-growing business needed to move from its most humble of beginnings, the garage of Jim's father-in-law, to that of a much larger manufacturing space, which eventually became too small as well.

Each year the company grew, adding new employees. Jim consistently made improvements to the frame's design and sourced superior materials. He expanded the product line to include more versatile frame models, quilting hoops and quilting accessories. There came a time when he saw the opportunity for a better frame in the machine quilting industry. The result was the original Grace Machine Quilter (GMQ), a quilting

frame that made machine quilting accessible for home quilters. The Grace Company became the number one producer of both machine and hand quilting frames. Besides manufacturing their own frames, the Grace Company also produces quilting frames for many well-known sewing machine companies.

The Grace Company consistently generates new and exciting ideas, experiments in new product design, and is always on the rise to better heights in excellence and quality. The Grace Company continues to go to great expense to take each product from concept to market by utilizing state-of-the-art software, in-house

rapid prototyping, and cost-efficient sourcing. Through these means, the Grace Company has been able to rapidly respond to market and customer needs and continues to lead the quilting industry.

After more than 35 wonderful years, The Grace Company continues in the tradition of creativity, innovation, and customer-centered service.

"I BELIEVE THERE IS A MARKET FOR A BETTER QUILTING FRAME."

- Grace Bagley, 1985

THE ORIGINAL GRACE FRAME



Table Of Contents

Q'NIQUE MACHINES 2

Shared Q'nique Features. 4

Q'nique 21X Elite Quilting Machine 10

Q'nique 19X Elite Quilting Machine 16

Q'nique 19X Quilting Machine. 20

Q'nique 16X Elite Quilting Machine 24

Q'nique 16X Quilting Machine. 28

Q'nique 16X Manual Quilting Machine 30

Q'nique Accessories. 32

Q'nique Machine Comparison 42

Q'nique Frame Compatibility. 44

Q'nique Technical Specs 46

QUILTING FRAMES 48

Cutie Tabletop Fabric Frame. 50

Q-Zone Hoop-Frame 56

Q-Zone Queen Frame 60

Quilter's Evolution Hoop-Frame 62

Quilter's Evolution Elite-Frame 64

Continuum II Quilting Frame 66

HAND QUILTING 68

Grace Hoop² DM 68

QUILTMOTION 70

QuiltMotion Quilter's Creative Touch 5 Pro 70

QuiltMotion Quilter's Creative Touch 5 Beginnings ... 90

QuiltMotion Quilter's Creative Touch Gold 92

Feature Comparison. 98

Using Your Own Windows Tablet. 99

Upgrade to QuiltMotion QCT5 Pro. 100

Machine And Frame Compatibility. 102

What's Included. 104

Specs & System Requirements. 105

Quilter's Creative Design Pro 106

ACCESSORIES 108

Luminess LED Light Station. 108

SureStitch Stitch Regulator 112

SureStitch Elite. 113

Plastic Pattern Perfect Basic Set. 114

Additional Pattern Templates 115

Free Motion Quilting Starter Kit 116

Gracie Laser. 118

G-Series Carriage 2 119

Grace Speed Control 120

Grace Company Quilt Clips. 120

Grace Company Quilt Clips. 121

Bungee Clamps. 121

Grace Company Cloth Leaders. 122

Finesse Quilting Thread. 124

TRUECUT 130

My Comfort Cutter. 132

StraightCut Cutter 134

TrueCut 360° 136

TrueCut Rulers. 138

TrueSharp2. 140

Linear Sharpener. 141

TrueCut Cutting Mats 142

TrueCut Non-Slip Pad. 143

Travel Kit. 144

TrueGrips 146

TrueGrips Hearts and Leaves 147

Rotary Blades. 147

WARRANTY AND GUARANTEE 148

Innovative Leaders of Quilting for 35 Years



The Grace Company consistently generates new and exciting ideas in product design, and is always on the rise in excellence and quality. The first Q'nique midarms revolutionized a new segment of the quilting industry, bringing professional features to quilting enthusiasts at an affordable price.

For over 35 wonderful years, the Grace Company has continued its focus on the customer in the tradition of creativity, innovation, and quality service.





Shared Q'nique Features

ULTIMATE QUILTING EXPERIENCE

Every aspect of each Q'nique machine has been carefully designed to heighten the quality of the machine, of the stitch, and of the entire quilting experience. You're going to love quilting with a Q'nique.



FAMILIAR QUILTING PROCESS

The process of quilting by moving the machine over the quilt fabric is intuitive, **like drawing with a pencil on paper**. You'll be amazed at how much this increases stitch accuracy and control.

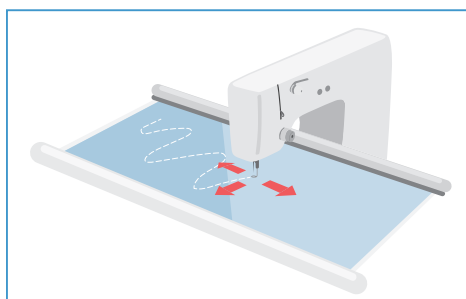



EASE OF USE

The Q'nique quilting machine line offers regulated stitching in mid and longarm machines never available before in such an affordable package. Designed by a team of dedicated engineers, these easy-to-use machines offer superior stitching and the latest quilting technology.

The soft, ergonomic handles follow the contours of your hand, allowing for comfortable, extended sessions of quilting.

All the quilting functions of the machine are easily controlled with the push of a button.



COMFORT-GRIP HANDLES



QUICK-ACCESS BUTTONS

ADJUSTABLE HANDLES FOR FULL CONTROL

The handles are the main way you interact with your quilting machine, so we designed the handles on the Q'nique X machines to give you the best experience possible in comfort and control.

The handles are fully adjustable, so you can quilt in the way that feels most natural. They can also be rotated down to a “*micro-handle*” position for more control of fine stitching.



SUPERIOR STITCH QUALITY

The Q'nique machines have been precisely designed for a beautiful, consistent stitch. All models except for the 16X Manual include ***built-in stitch regulation***, a feature normally only found on more expensive machines.



HIGH-QUALITY ENCODERS

All the Q'nique machines feature built-in stitch regulation. High-resolution encoders track the machine's movement and tell the motor how fast or slow to stitch, so all of your stitches consistent.



4 DIFFERENT STITCH MODES

Each of the stitch regulated Q'nique machines feature four different stitch modes for maximum control over your quilting.

PRECISE MODE

In “precise” mode, you control the stitches-per-inch (SPI) setting for consistently sized stitches. Stitch regulation adjusts the stitch speed as you quilt faster or slower. Precise mode stops stitching when you stop moving the machine.

CRUISE MODE

In “cruise” mode, you set the SPI and the minimum stitching speed. Regulation adjusts to keep stitches consistent, but whenever you stop or slow your movements, the machine will continue to stitch at the minimum set speed.

MANUAL MODE

The “manual” mode lets you control the stitch speed of the quilting machine. With the buttons on the handle bars, you can increase or decrease the constant speed. This is great for detailed or intricate stitching.

BASTE MODE

Use “baste” mode for basting the edges of your quilt. Stitch length can be set to short, medium or long.



User Friendly Operation

Q'nique machines have been specially designed to be quilter-friendly and as easy to use as possible, all while integrating the latest technology available.

LED WORK LIGHTS

You'll love the high-powered LED work lights that illuminate your stitching and reduce eye-strain. Each stitch is defined with color-accurate, day-light balanced lighting.

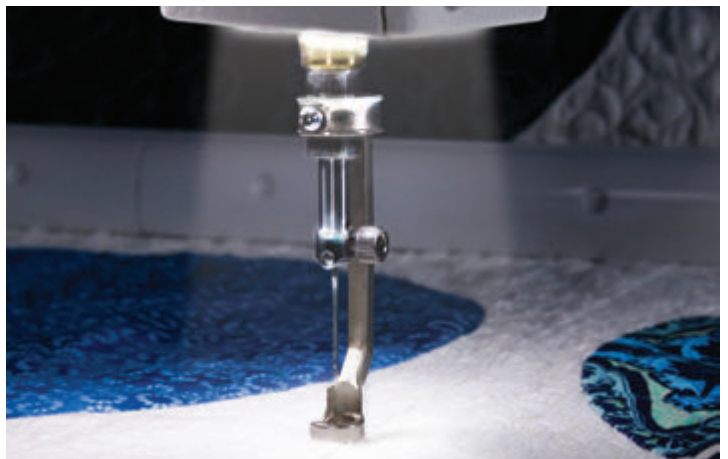

Throat Space Advantage

GET MORE DONE WITH MORE SPACE

The Q'nique machines have a large throat space. This extended work area gives you the freedom to quilt larger patterns and blocks than possible on a standard sewing machine.

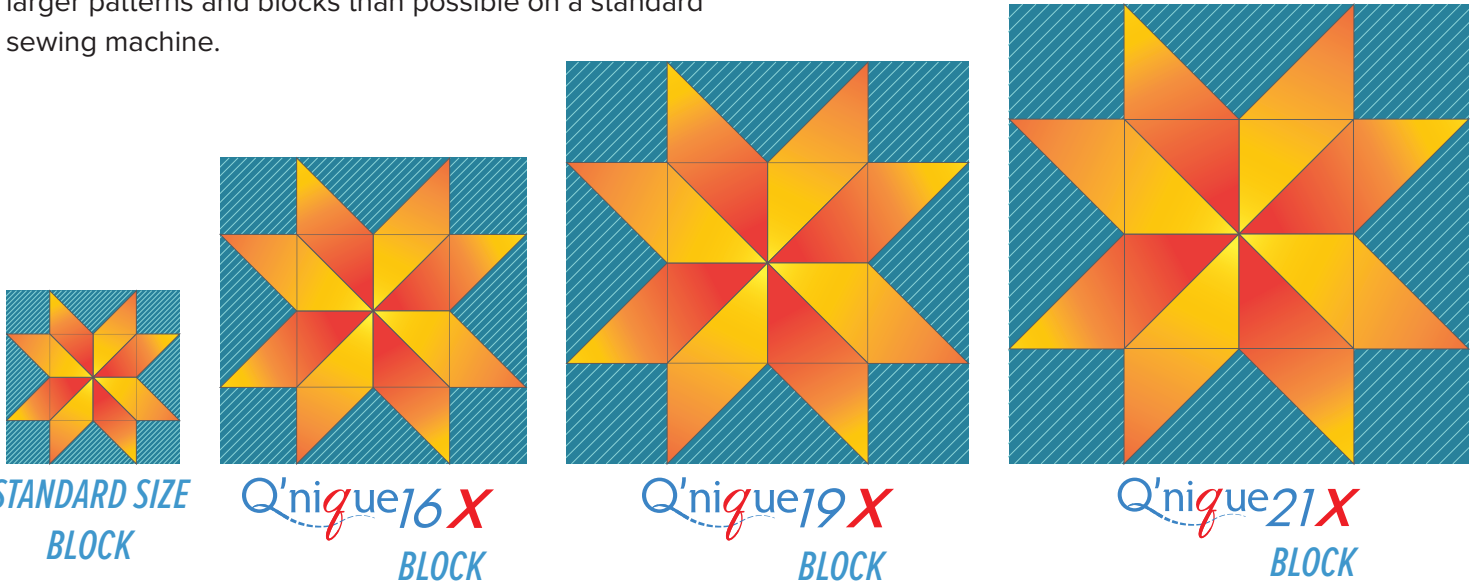

WHAT IS THROAT SPACE?

Throat space is the distance from the needle to the neck of the machine. The larger the throat space, the larger the blocks and patterns you can quilt at one time.



Q'nique™ 21X
ELITE



Q'nique 21X Elite Only **\$9,499.95**

With Any Size Continuum II Frame **\$12,499.90**

Q'nique 21X Elite Quilting Machine

The Q'nique 21X Elite quilting machine gives you the furthest reach, the most advanced and intuitive features, and the most impressive quilting experience you've ever had. The incredible power, smooth motion, and smart technology of this longarm will amaze you.



SEE HOW IT WORKS!



<https://bit.ly/21xelite>



FAST, SMOOTH, AND QUIET

The 21X Elite is our fastest, smoothest, and quietest machine yet. On a track and carriage system, even at 2600 stitches per minute, it glides with ease across the fabric. Engineered to reduce vibration, this machine is quiet and stable as well as fast, making it ***perfect for fine detailed stitching.***



BIGGER, BETTER TOUCHSCREEN

The 7" full-color display is easy to see and navigate. It provides a variety of tools and options at your fingertips, including on-screen help guides and user-friendly instructions.

NEW ADVANCED FEATURES FOR THE BEST IN QUILTING CONVENIENCE

MEASURE TOOL

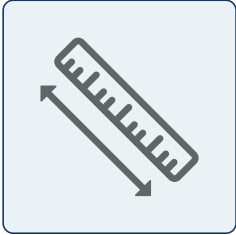

By simply moving your machine, you can easily measure any seam, line, block, or pattern!

BOBBIN ESTIMATOR

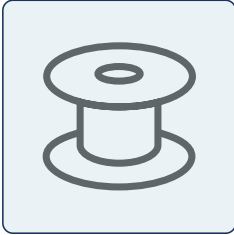

Take the guesswork out of how much bobbin thread is left! Save custom bobbin settings for different types of thread.

EDGE WARNING

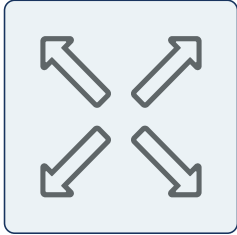

Warning system alerts you when you're about to quilt outside of your designated quilting area.

BOBBIN ESTIMATOR

With the on-screen bobbin estimator, you never have to guess how much longer your bobbins will last! You can even save multiple bobbin settings to use for different types and sizes of thread.



INCLUDED MAGNIFIQUE

This included magnifying glass makes threading your needle much easier. It can also be attached to the included handle for up close inspection of the stitching anywhere on the quilt.

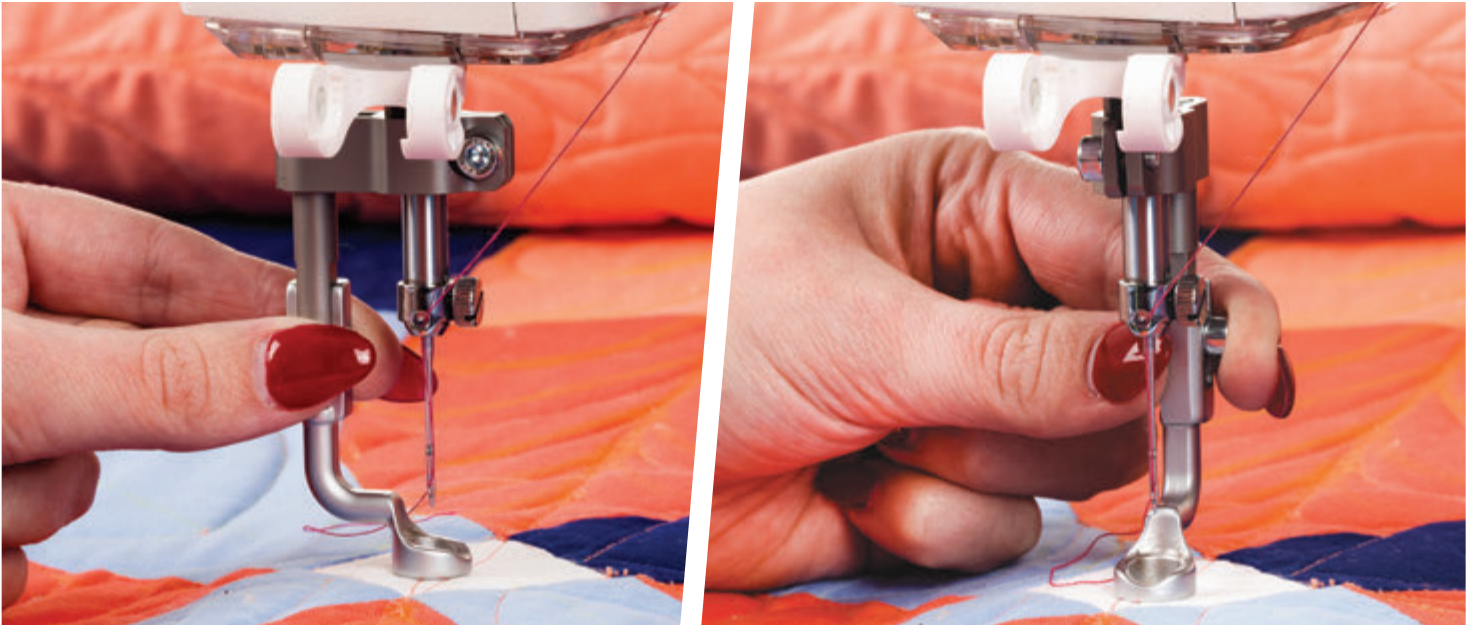

POSITIONABLE HOPPING FOOT

The patented hopping foot of the Q'nique 21X Elite can be switched to the back or side of the needle for optimal visibility.

GET MORE DONE WITH MORE SPACE



Q'nique™ 19X ELITE



Q'nique 19X Elite \$8,499.95

Q'nique 19X Elite Quilting Machine

The Q'nique 19X Elite is the perfect way to upgrade your quilting experience. This machine's extensive throat length, advanced functionality, and familiar user-friendly design will make it the star of your quilting space.



FAMILIAR FEEL

Making the leap to a longarm machine can be intimidating, but the Q'nique 19X Elite makes it easy! This machine is lightweight and easily maneuverable compared to other longarms.

7" FULL-COLOR TOUCHSCREEN

The Q'nique 19X Elite features a highly accessible, intuitive touchscreen display. Navigate menus and select settings with the touch of a finger. This machine is designed with all of the same convenient advanced features as the 21X Elite, like the measure tool, bobbin estimator, and edge warning system.



BUILT-IN BOBBIN WINDER

This machine comes with an automatic bobbin winder with fill-level sensors and easy-to-use start and stop controls.



ADJUSTABLE HANDLES

The handles of the Q'nique 19X Elite can be adjusted to the most comfortable position for you, so you can quilt longer without any aches and pains.

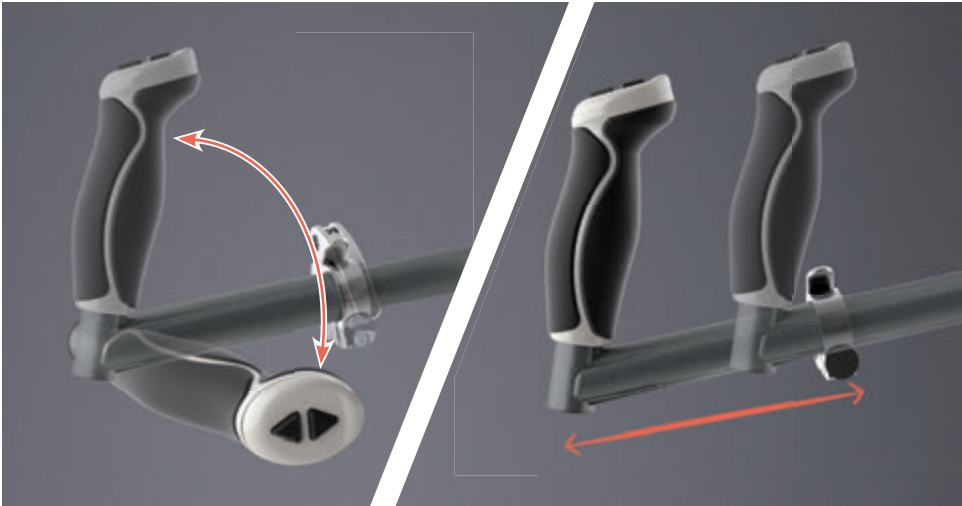

19" THROAT SPACE



Q'nique™ 19 X



Q'nique 19X \$7,299.95

Q'nique 19X Quilting Machine

The new Q'nique 19x makes the transition to a longarm easy and exciting! Making the leap to a longarm machine can be intimidating because of its size and complexity compared to most home machines. This machine strikes a perfect balance between the professional features you'd expect from a longarm and the comfortable feel of your home sewing machine.

2,000 STITCHES PER MINUTE



AS COMFORTABLE AS YOUR HOME SEWING MACHINE

Everything about the latest 19X machine has been designed to make your quilting time easy and comfortable. The body of the machine glides easily

as you move it, and controls are simple to use. The handles are adjustable, so you can quilt longer with reduced stress on your arms and back.



2.4" TOUCH SCREEN

The touch screen puts all of the machine's features right at your finger tips. New features like the edge warning tool can be easily accessed from this user-friendly screen.

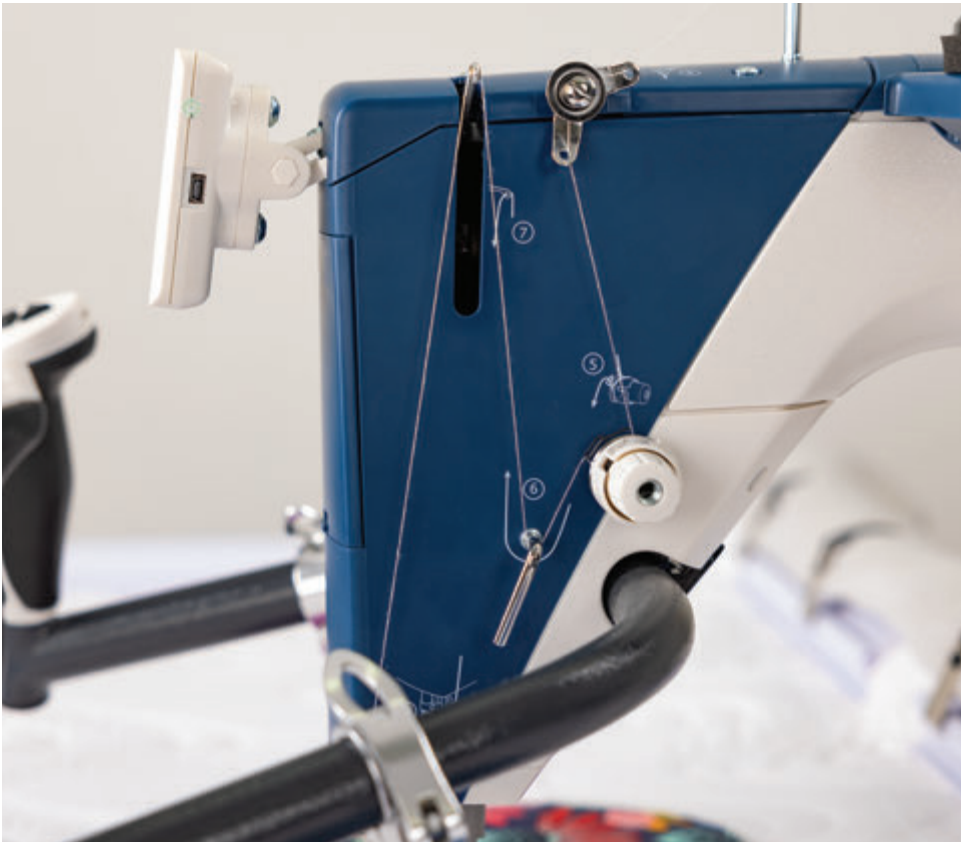

PRINTED THREAD GUIDES

Threading the machine is now easier than ever. A step-by-step guide is printed next to each point to be threaded.

Q'nique™ 16 X ELITE



Q'nique 16X Elite \$5,999.95

Q'nique 16X Elite Quilting Machine

The Q'nique 16X Elite Quilting Machine is at the top of the 16X series. It continues the innovations of the other Q'nique X-Series machines in a smaller, user-friendly machine that is prepared to elevate your quilting.

Capable of stitching up to 2,100 stitches per minute, this machine can power through any project with ease.



IMPROVED BOBBIN WINDER

This machine comes with a redesigned automatic bobbin winder with fill-level sensors and easy-to-use start and stop controls.



16" THROAT SPACE



ADDITIONAL LIGHTING

This machine is ready to give you more light where you need it most. The bobbin light lights up the hook assembly area while the LED throat lights create an even brighter, shadow-free workspace.

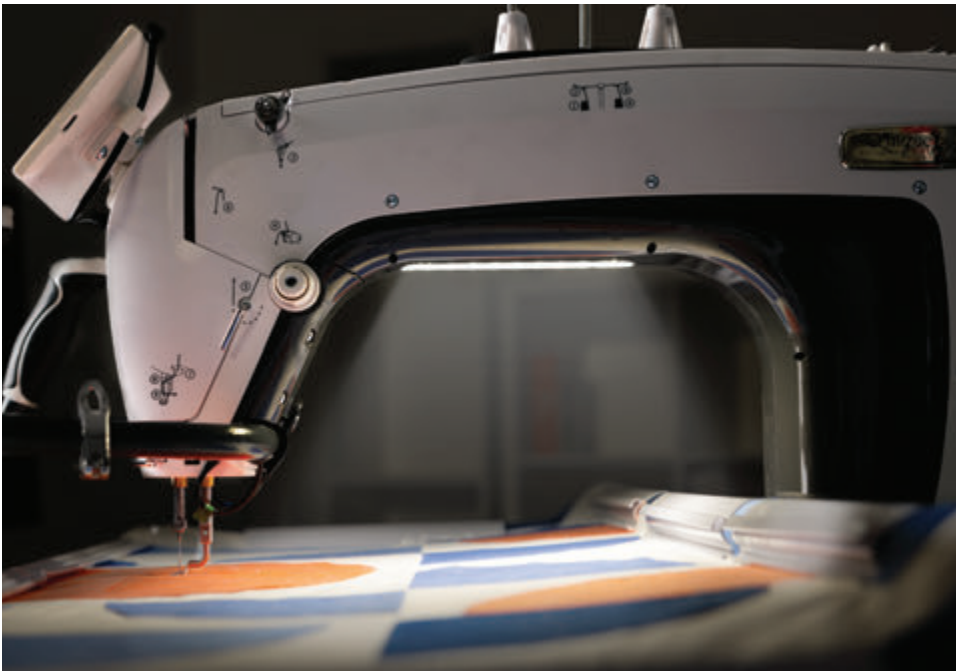

ELITE 7" TOUCH SCREEN

The large touchscreen display provides easy access to the four main quilting modes along with helpful tools such as an improved bobbin estimator and patented edge warning.



Q'nique™ 16 X



Q'nique 16X Quilting Machine

Q'nique 16X \$4,999.95

The Q'nique 16X is an excellent entry into the 16X series. With a motor that can run up to 1,700 stitches per minute, this machine can help you easily complete even the largest of projects.

BUILT IN SCREEN

The preinstalled 2.4" touch screen provides access to many of the same tools and features as the 16X Elite, including the patented edge-warning.



Q'nique™ 16 X MANUAL



Q'nique 16X Manual Quilting Machine

Q'nique 16X Manual \$3,999.95

The Q'nique 16X Manual is a manual-mode-only machine without stitch regulation that starts at an amazing price point for quilting enthusiasts. It can run up to 1,700 stitches per minute, making any project a breeze.



MANUAL SPEED MACHINE

The Q'nique 16X Manual offers excellent stitch quality with simple manual speed control. Move at your own pace and create detailed and intricate stitching.

The light-up speed gauge on the front of the machine lets the user know how fast the machine is stitching.



EASY TO UPGRADE

Designed with the future in mind, this machine can be easily upgraded to the 16X machine in a matter of minutes without ever needing to leave your home.

Q'nique Accessories

Q'nique Laser Stylus \$139.95

Q'nique Ruler Base \$169.95



Q'NIQUE LASER STYLUS

Easily trace patterns or photographs with the Q'nique Laser Stylus. Attach the laser stylus to the Q'nique quilting machine, and trace the desired pattern to copy it onto your quilt! The laser can be attached to the front or rear handles, or the bottom of the machine, between the wheels.

RULER BASE

Add the Ruler Base when machine quilting on your frame to help with using rulers, straight-edges and templates. The ruler base adds a stable surface around the needle and under the quilt, and it is easily attached and removed.

MR NEEDLES

Our new MR Needles are specialized to make multi-directional free motion quilting even easier. With its special blade and scarf design, the Groz-Beckert MR needle offers outstanding resistance to bending and breaking.

Available in a set of 10 in size 14, 16, or 18.



MR Needles \$8.95

Q'nique 21X Elite Rear Handles **\$649.95**

Q'nique 16X Elite Rear Handles **\$649.95**

Q'nique 19X Elite Rear Handles **\$649.95**

Q'nique 16X Rear Handles **\$549.95**

Q'nique 19X Rear Handles **\$549.95**

REAR HANDLES

This quilting accessory is essential for using any pantographs or patterns from the back table of your machine quilting frame. These rear handles feature the same quick-access buttons as the regular handles and provide a connection for the display so you can control all of the functions and settings right from the rear of the machine.

Note: Rear handles are designed for compatibility with a specific machine. Trying to use them on an incompatible machine will damage it.



Q'NIQUE 21X ELITE

Q'NIQUE 19X ELITE

Q'NIQUE 19X



Q'NIQUE 16X ELITE

Q'NIQUE 16X





Ruler Templates \$19.95

RULER TEMPLATES

Pair a ruler foot and ruler template to guide your design. As you stitch, slide the ruler foot along the edge of the ruler template.

Templates are available in ¼ inch thicknesses for longarm and midarm machines, and ⅛ inch thicknesses for smaller home quilting/sewing machines.

SUPER SLIDE

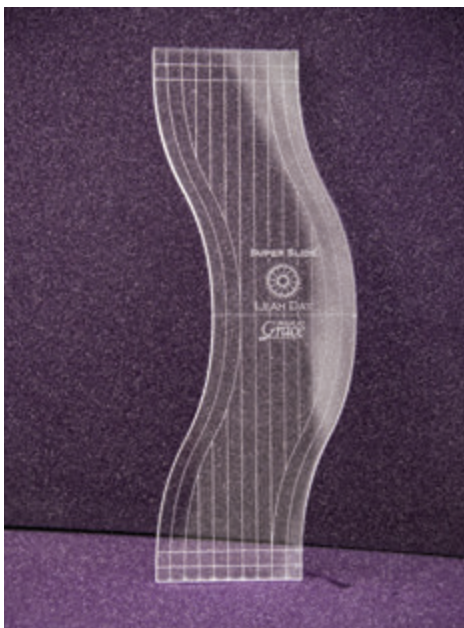

SLICE

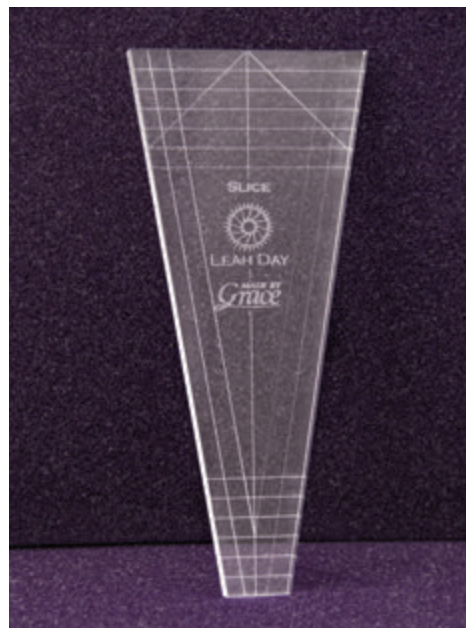

MINI SLIDE

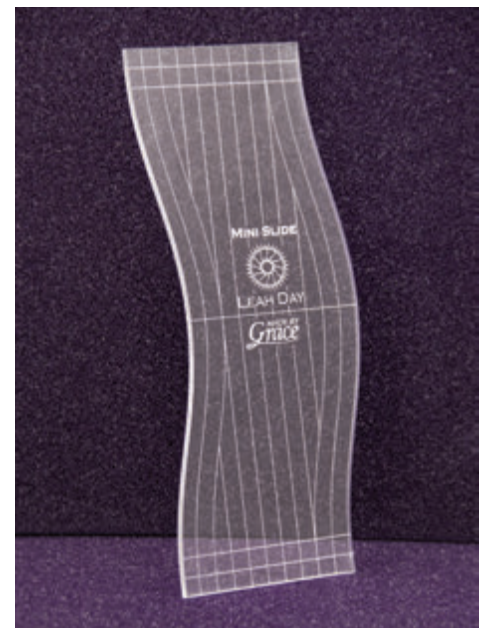



Horizontal Spool Holder **\$49.95**

Bobbin Case **\$79.95**

Machine Needles
(Size 14, 16, or 18 in sets of 10) **\$7.95**

M-Class Bobbins (Set of 10) **\$29.95**

**HORIZONTAL
SPOOL HOLDER**

The horizontal spool holder enables you to quilt with spools of thread as well as cones. This is compatible with all Q'nique machines.

BOBBIN CASE



MACHINE NEEDLES



M-CLASS BOBBINS



9-Piece Foot Attachment Set **\$199.95**

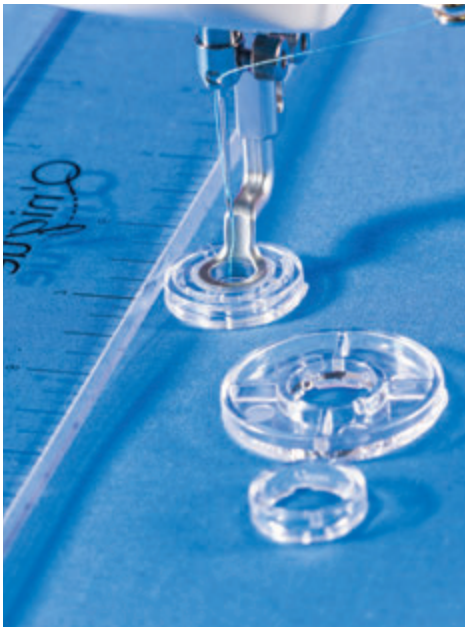

9-PIECE FOOT ATTACHMENT SET

A set of 9 hopping foot attachments is available for the Q'nique machines. Attach one of these tools to the included hopping foot to create amazing quilting designs! Each set includes couching feet for yarn, a glide-foot for free-motion quilting, echoing feet, and feet to use with rulers.



GLIDE FOOT

Standalone Glide Foot **\$59.99**

The Glide Foot is a foot attachment for any Q'nique machines released in 2021 or later. It makes free-motion quilting so easy because this foot glides across your fabric.

Q'nique Hopping Foot Set \$169.95

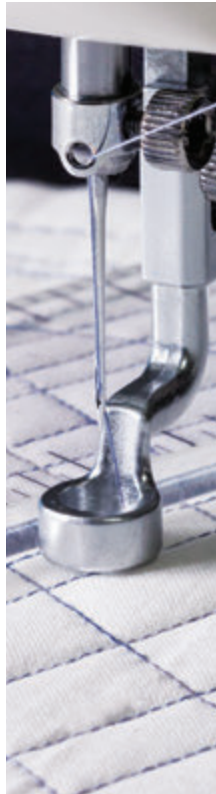
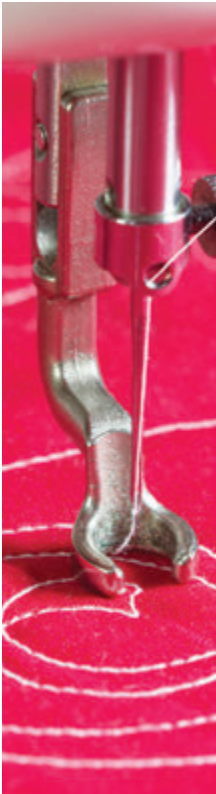

Q'NIQUE HOPPING FOOT SET

Additional hopping feet made for the Q'nique X machines. This set includes an open toe foot, ruler foot, and micro-stippling foot. The set will work with any Q'nique in the X series. A set for older Q'nique machines is also available.

OPEN-TOE FOOT

The Open-Toe Foot allows for full visibility of the needle and great for applique, thread painting, and artistic quilting.

RULER FOOT

The Ruler Foot is a thicker toe for use with rulers & templates which are sold separately and has a height-ened bend in the foot which clears most quilting rulers

MICRO-STIPPLING FOOT

The Micro-Stippling Foot allows for very fine, detailed stitching and easier background quilting.



360 Wonderfoot

360 Wonderfoot \$189.95

The 360 Wonderfoot is a truly unique hopping foot that makes tasks like stitching in the ditch, offsetting stitch lines, and pattern tracing easy and fun. With full 360° rotation and five interchangeable inserts, the Wonderfoot helps you make beautiful work with less effort.



FIVE EASILY INTERCHANGEABLE INSERTS

Each insert has a specific function, from stitching in the ditch to echoing patterns and curves. The insert guides help keep you on track as you stitch.

SEE HOW IT WORKS!



<https://bit.ly/wonderfoot>

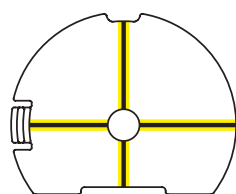

STITCH IN THE DITCH

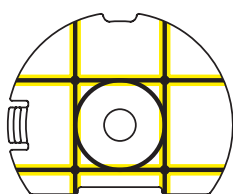

1/4" OFFSET

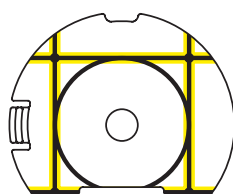

3/8" OFFSET

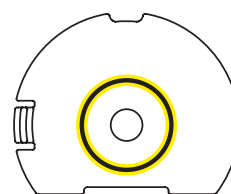

1/4" CIRCLE

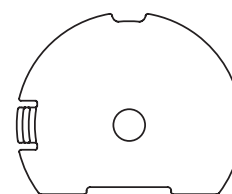

CLEAR

Quilt Perfect Ruler Kit

Quilt Perfect Ruler Kit **\$189.95**

This hopping foot kit provides different benefits for using a ruler while quilting. Each of the three feet has a specific function to help quilters improve their precision and accuracy:

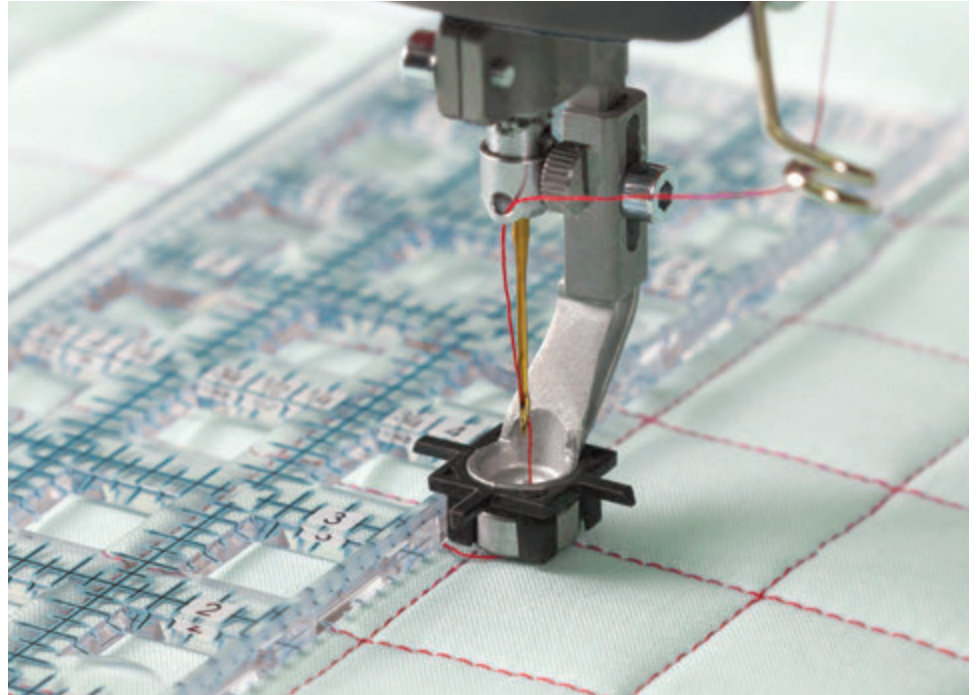

TRUECUT TRACK FOOT

Designed specifically to work with the TrueCut rulers, this foot locks onto the ruler track for precise straight lines.



ROLLING FOOT

This foot reduces glides along your ruler with less friction so your machine moves more smoothly with less effort.



PRECISION FOOT

This four-pointed foot helps identify the point on a quilt where you can stop, allowing for improved accuracy.

Magnifique

Magnifique \$99.95

THE PERFECT SOLUTION TO EASILY THREAD YOUR NEEDLE EVERY TIME



The Magnifique assists quilters with tasks like threading their machine's needle by providing them with a closer view. The accessory can be easily mounted to your machine, and the magnifying glass itself can be positioned on the machine or removed to be handheld. The magnifying glass comes with three different swappable lenses: 2x, 3.5x, and 5x magnification

One of the benefits of this product is its magnification — providing a better view to make the more intricate parts of the quilting process easier. However, this accessory has the additional benefit of functioning as a regular magnifying glass for everyday use with our handle that we have included.





Q'nique Machine Comparison

			
STITCH MODES	Manual Cruise Precise Baste	Manual Cruise Precise Baste	Manual Cruise Precise Baste
THROAT SIZE	21"	19"	19"
STITCH SPEED (SPM)	2,600	2,600	2,000
STITCH REGULATION	Yes	Yes	Yes
SCREEN TYPE	7" Full-Color Touch Screen	7" Full-Color Touch Screen	2.4" Touch Screen
EDGE WARNING TOOL	Yes	Yes	Yes
BOBBIN ESTIMATOR TOOL	Yes	Yes	No
PRICE	\$9,499.95	\$8,499.95	\$7,299.95

			
STITCH MODES	Manual Cruise Precise Baste	Manual Cruise Precise Baste	Manual
THROAT SIZE	16"	16"	16"
STITCH SPEED (SPM)	2,100	1,700	1,700
STITCH REGULATION	Yes	Yes	No
SCREEN TYPE	7" Full-Color Touch Screen	2.4" Touch Screen	LED speed indicator
EDGE WARNING TOOL	Yes	Yes	No
BOBBIN ESTIMATOR TOOL	Yes	No	No
PRICE	\$5,999.95	\$4,999.95	\$3,999.95

Grace Frame Compatibility

The **Q'nique 21X Elite** is only compatible with the Grace Company Continuum, Continuum II Frame, Quilters Evolution Hoop-Frame, and Quilters Evolution Elite-Frame.

The Q'nique 16X and 19X series machines will work with the following Grace Company quilting frames.

Q'NIQUE 16X & 19X SERIES FRAME COMPATIBILITY LIST	Q'nique™16X	Q'nique™19X
<i>Cutie Tabletop Fabric Frame</i>	Yes	Yes
<i>Q-Zone Hoop-Frame</i>	Yes	Yes
<i>Q-Zone Queen</i>	Yes	Yes
<i>Continuum or Continuum II</i>	Yes	Yes
<i>Quilters Evolution Hoop-Frame</i>	Yes	Yes
<i>Quilters Evolution Elite-Frame</i>	Yes	Yes
<i>GQ Frame</i>	Yes	Yes*
<i>Q'nique 14+ Frame</i>	Yes	No
<i>Gracie King/Gracie Queen</i>	Yes	Yes
<i>SR2 / SR2+</i>	Yes	No
<i>Majestic</i>	Yes	Yes
<i>GMO PRO</i>	Yes*	Yes*
<i>Little Gracie II</i>	Yes*	Yes*
<i>Pinnacle</i>	Yes	Yes
<i>Next Generation</i>	Yes*	Yes*

* With carriage upgrade

Other Brand Frame Compatibility

The Q'nique 16X and 19X series machines will work with the following quilting frames from other brands.

Q'NIQUE 16X & 19X SERIES FRAME COMPATIBILITY LIST	Q'nique™16X	Q'nique™19X
<i>Non-Grace Brand Frames</i>		
<i>Inspira iQuilt Frame</i>	Yes	Yes*
<i>Janome Artistic Frame</i>	Yes	Yes
<i>Bernina Frame (Single-Track)</i>	Yes*	Yes*
<i>Bernina Frame (Dual-Track)</i>	Yes	Yes*
<i>SVP Imperial Frame</i>	Yes	Yes*
<i>Kathy Quilts Launch Pad</i>	Yes	No
<i>Baby Lock Momentum (Cadence)</i>	Yes	Yes
<i>Tin Lizzie Phoenix</i>	Yes	Yes
<i>Juki</i>	Yes	Yes

* With carriage upgrade

Q'nique Technical Specs

Q'nique™ 21X ELITE

PHYSICAL DIMENSIONS

Length: 37 inches
Height: 32 inches
Width: 15.5 inches

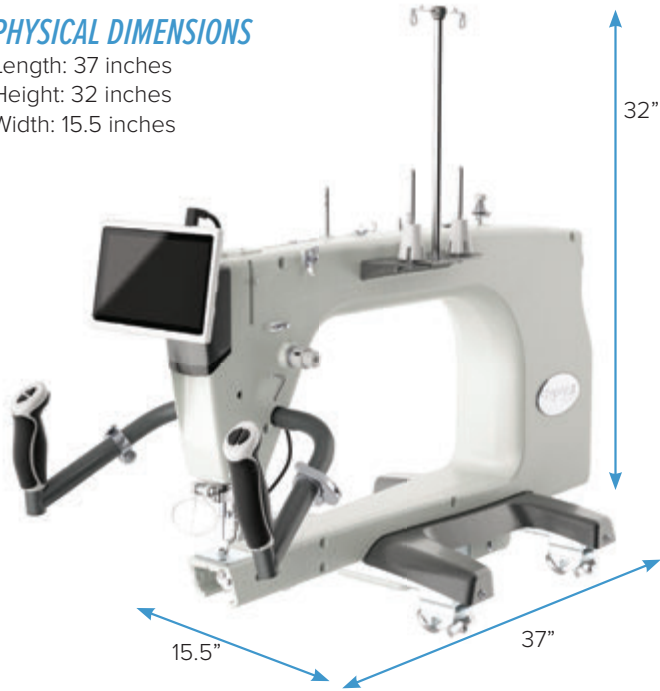

EXTENDED WORK AREA

Length: 21 inches
Height: 10.5 inches

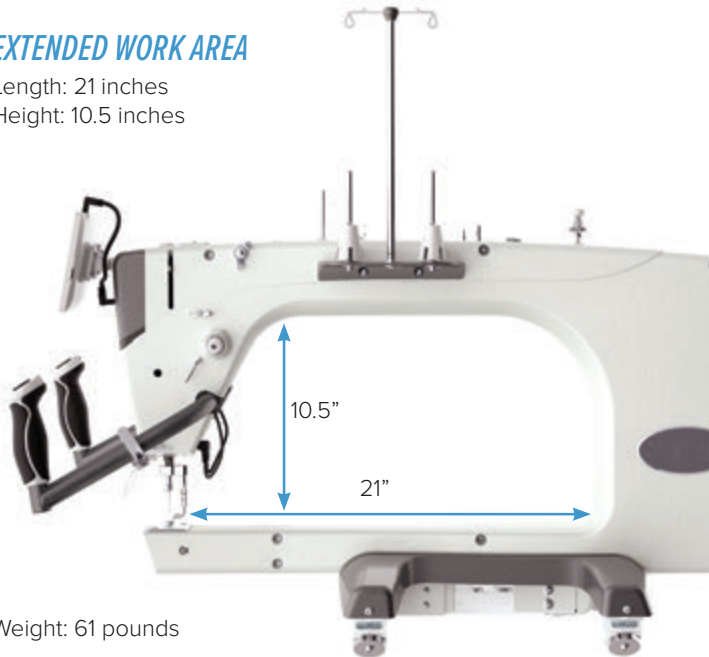

Weight: 61 pounds

Q'nique™ 19X AND X ELITE

PHYSICAL DIMENSIONS

Length: 32.5 inches
Height: 29 inches
Width: 15.5 inches

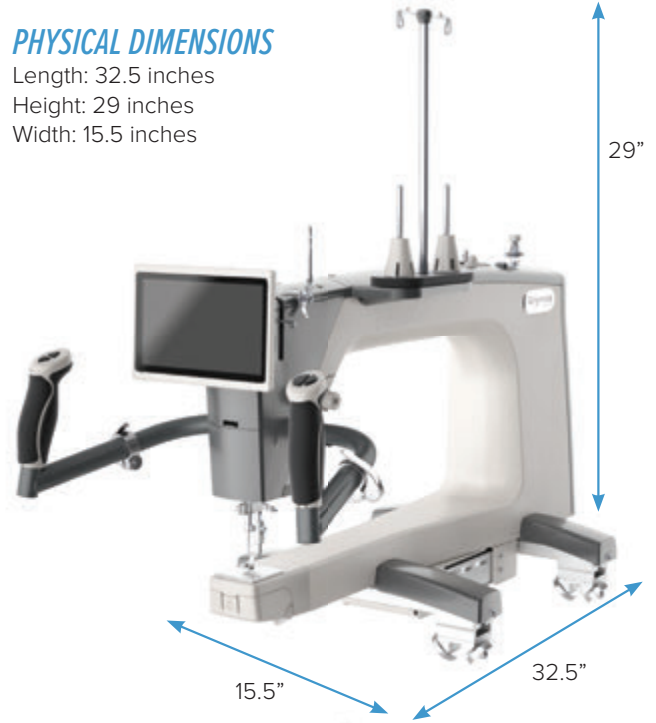

EXTENDED WORK AREA

Length: 19 inches
Height: 9 inches

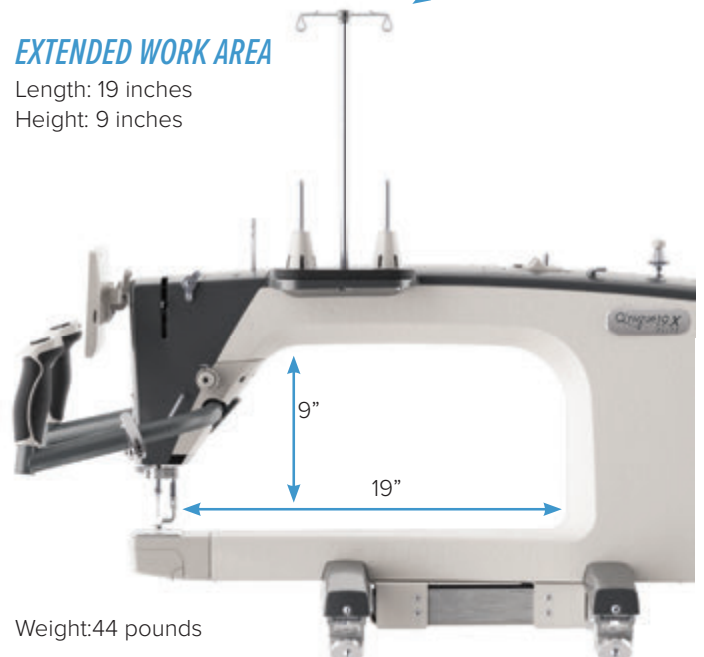

Weight: 44 pounds

Q'nique™ 16X

AND X ELITE AND MANUAL

PHYSICAL DIMENSIONS

Length: 29 inches
Height: 31 inches
Width: 15.5 inches

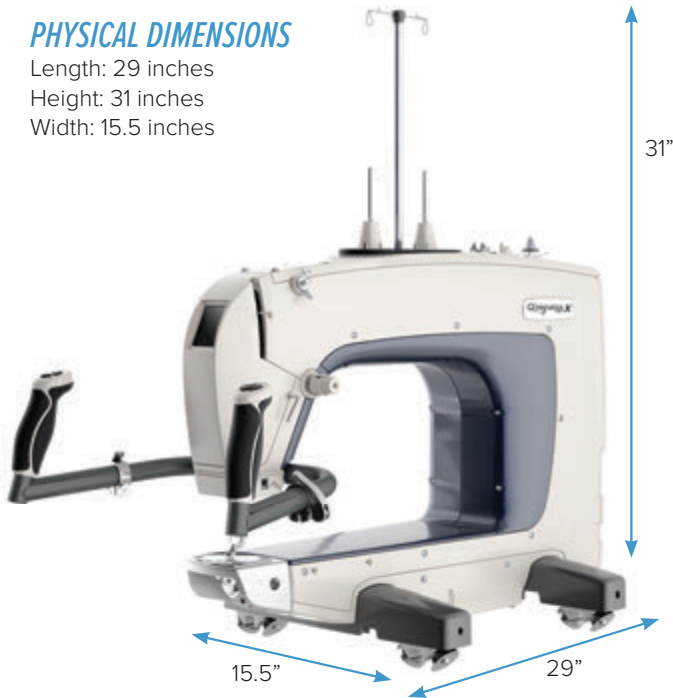

EXTENDED WORK AREA

Length: 16 inches
Height: 8.25 inches

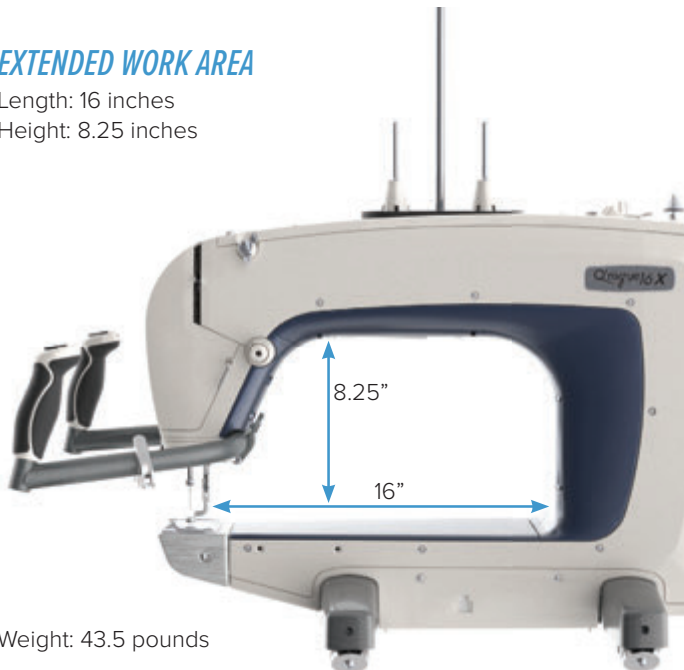

Weight: 43.5 pounds

Q'NIQUE SPECIFICATIONS

QUILTING FEATURES

- Built-in stitch regulation (Except for 16X Manual)
- LED needle lights
- Quick-access handle buttons
- Easy-change bobbin case
- Built-in bobbin winder
- Dual thread cone holders
- Commercial grade aluminum body

SEWING SPECS

- Maximum sewing speed:
 - 1,700 SPM (16X and 16X Manual)
 - 2,000 SPM (19X)
 - 2,100 SPM (16X Elite)
 - 2,600 SPM (21X Elite, and 19X Elite)
- Stitches Per Inch: 4-16 SPI
- 3 regulated modes: precise, cruise, and baste (except for 16X Manual)
- Manual speed control available
- Over-Speed warning (warns when movement is too fast for current stitch regulation settings)

OTHER SPECS

- Bobbin-type: M-Class bobbin
- Input Voltage: 100-240 VAC
- Power consumption:
 - 250W Max. (16X and 16X Manual)
 - 300W Max. (19X)
 - 350W Max. (16X Elite)
 - 450W Max. (19X Elite and 21X Elite)
- Screen language: English

Quilting Frames

CHOOSING A FRAME

Before choosing a frame, it is best to learn which features are most important for you and your projects. No matter your quilting needs, there is a Grace frame that's right for you.

KNOW YOUR FRAMES: ROLLING VS. HOOP

There are two main categories of quilting frames. Each type has unique benefits depending on your specific quilting preferences and style.

ROLLING FRAMES

These frames have two to four rails. The backing, batting and top layer can be rolled independently onto separate rails, or the top and batting can be “floated” on the backing between just two rails. All the fabric layers come together through the throat of the machine on the take-up rail. When using a rolling frame, you will quilt from one edge of the quilt to the other, and then roll your quilt up to the next section.

HOOP-FRAMES

Much like hand-quilting hoops, “hoop-frames” allow you to create quilts larger than the frame itself. All three layers of your quilt are sandwiched together before clamping them onto the frame for quilting. When using a hoop-frame, you will quilt in zones/sections across the width of the quilt and then down.



Quilting Frames

PROJECT SIZE

Will your projects ever include a king-size quilt? Rolling frames, like the Continuum II and Q-Zone Queen can be used for quilts only as large as the size they are set

up in. You couldn't quilt a king-sized quilt on queen-sized rolling frame. Hoop-frames can be used for quilts of any size



SEWING MACHINE SIZE:

What size is your machine? All current Grace frames can accommodate most shortarm and midarm machines with up to a 19" throat. Only the Continuum II Frame can hold machines with up to 21" throat. Make certain your sewing machine will fit on the frame before you purchase.

Cutie Tabletop Fabric Frame

\$1,199.95

Have you ever wanted to try out quilting, but decided not to because of the commitment to everything that goes with it? The Cutie Tabletop Fabric Frame allows you to quilt, sew, and stitch to your heart's content in a much easier way, managing your fabric so you can enjoy the process more. This frame fits on top of a table or desk and is compatible with most sewing machines.

Cutie
Tabletop Fabric Frame



WHAT OTHERS ARE SAYING

"This fits my small house perfectly! I have it set up on a small folding table at the rear of my living room, and can take it all down to store as needed. It was also easy to assemble!"

—ROSE H.

"I have been wanting something to quilt on. This is a perfect size and price. Love it so much!"

—NITA B.

COMPATIBILITY

The Cutie Frame is cross-brand compatible. It works with many different quilting machines, from domestics to longarms with up to a 19-inch throat space.

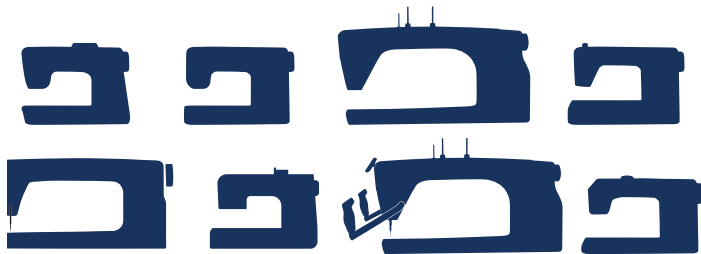

WORKS WITH MACHINES UP TO 19"



TOP-PLATE MAXIMUM MACHINE SIZE

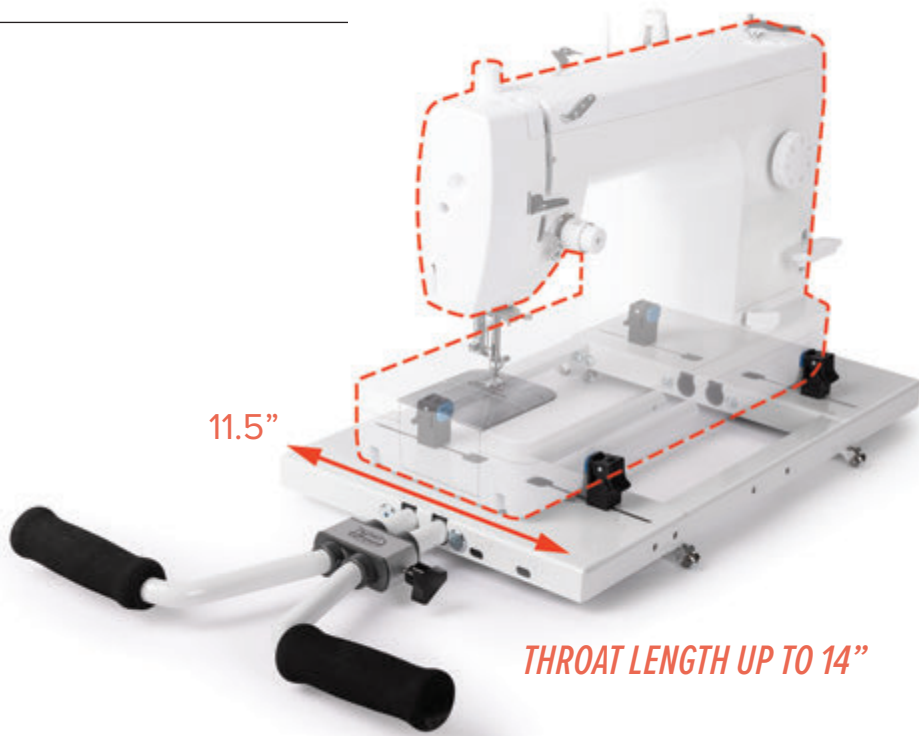

THROAT LENGTH UP TO 14"

SEE HOW IT WORKS!



<https://bit.ly/thecutie>

Maximum size of domestic machines using the top-plate with the attached handles:

Width: 11.5 inches

Throat Length: 14 inches

Note: If you plan to use a Q'nique 15, 16X, or 19X with this frame, you will not need the top-plate. The Q'nique will sit directly on the tracks of the bottom carriage.

WILL MY MACHINE WORK?

Ask yourself the following questions. If you answer yes to these, your home sewing or quilting machine can be turned into a full quilting system with the Cutie Frame!

CAN YOUR MACHINE'S FEED DOGS BE DISENGAGED?

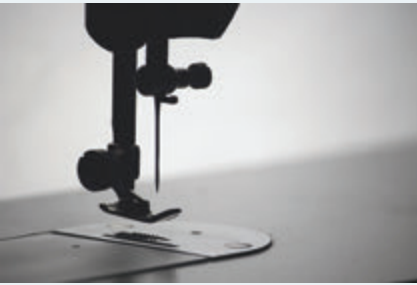

Free motion quilting on the Cutie requires the machine to sew in any direction, so you have to disengage your feed dogs.

DOES YOUR MACHINE FIT ON THE CARRIAGE?



The top plate of the frame can accommodate any home machine that's less than 11.5 inches wide. The Q'nique 16 and 19 machines will also work on the Cutie.

DOES YOUR MACHINE HAVE A FOOT PEDAL?



Control your machine like normal with its foot pedal under the table. (Foot pedals with cords shorter than 4.5 feet may need a cord extension.)



OTHER FEATURES

QUILT STANDING OR SITTING



ADJUSTABLE HANDLES

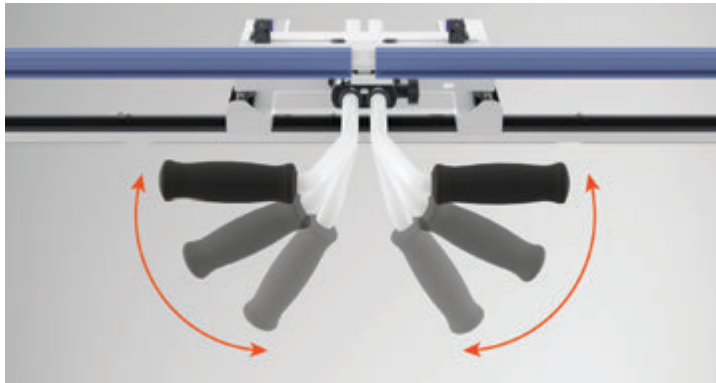

EASILY STOWABLE



UPGRADES EASILY



ADJUSTABLE DEPTH

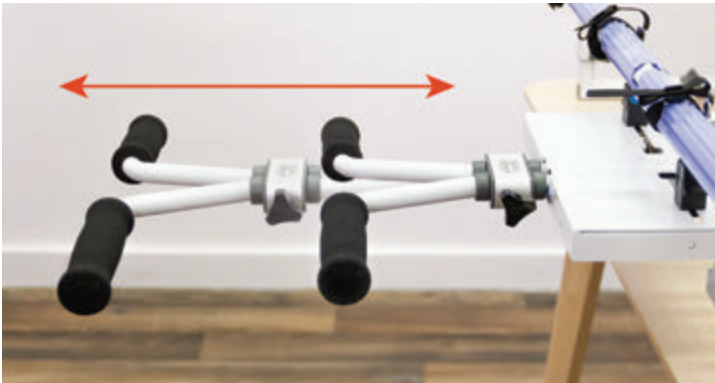

PREMIUM DUAL-TRACK SYSTEM



QUILT ANY SIZE WITH THE CUTIE

Like the Q-Zone Hoop-Frame, your quilt size is no longer limited by the width of the frame! Quilt king-size and larger, all on this 4 foot frame, using our new zone-to-zone quilting method.

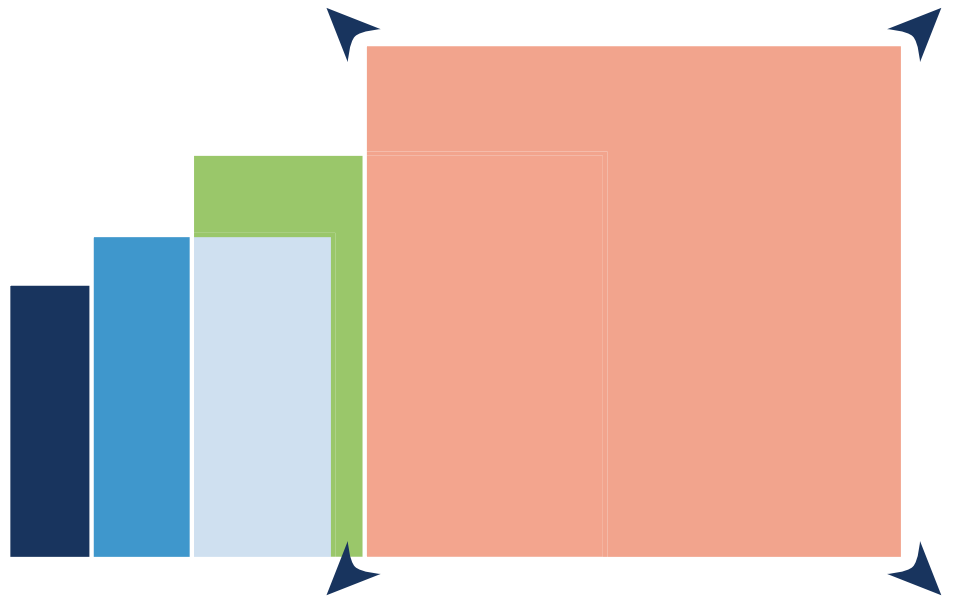

ANY SIZE: QUEEN, KING, OR LARGER!

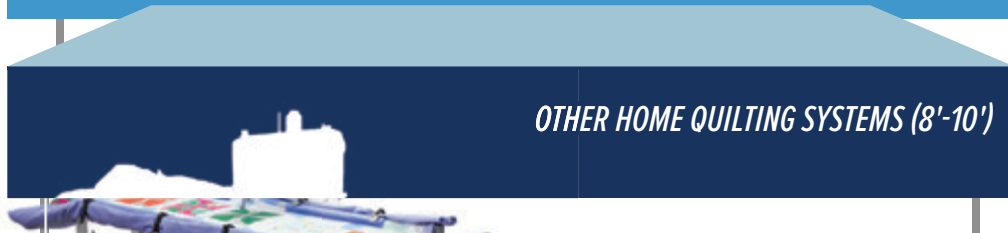

*CUTIE TABLETOP FABRIC FRAME
ONLY 4 FEET!
USE WHEN YOU WANT, STOW WHEN YOU DON'T*

WELCOME TO FREE MOTION

Your machine glides easily over the fabric in any direction, like drawing with a pencil on paper. That's right, quality artistic stitching has never been this easy.



OPTIONAL ACCESSORIES

LEG ACCESSORY \$399.95

If you are looking to elevate your quilting setup, this is the accessory for you. Simply attach your Cutie and enjoy instant stability and comfort as you sew. This accessory is height adjustable between 32 and 45 inches to accommodate all crafters.



CHANNEL LOCKS \$19.95



SPEED CONTROL \$79.95



SURESTITCH STITCH REGULATOR \$599.95



Q-Zone Hoop-Frame

\$1,699.95

The Q-Zone Hoop-Frame is a whole new type of machine-quilting frame that easily manages fabric like a simple hoop. With its small space-saving size you can set it up in any room and still quilt even the largest projects! Quilt standing or from your favorite chair. The small footprint of the frame allows you to reach both ends with your quilting machine while sitting.



COMPATIBILITY

The Q-Zone Hoop-Frame is cross-brand compatible. It works with many different quilting machines, from domestics to longarms with up to a 19-inch throat space.

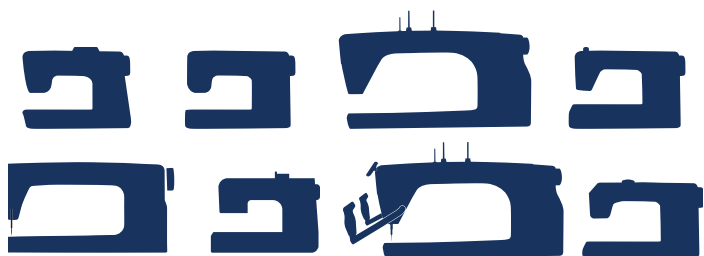

TOP-PLATE MAXIMUM MACHINE SIZE

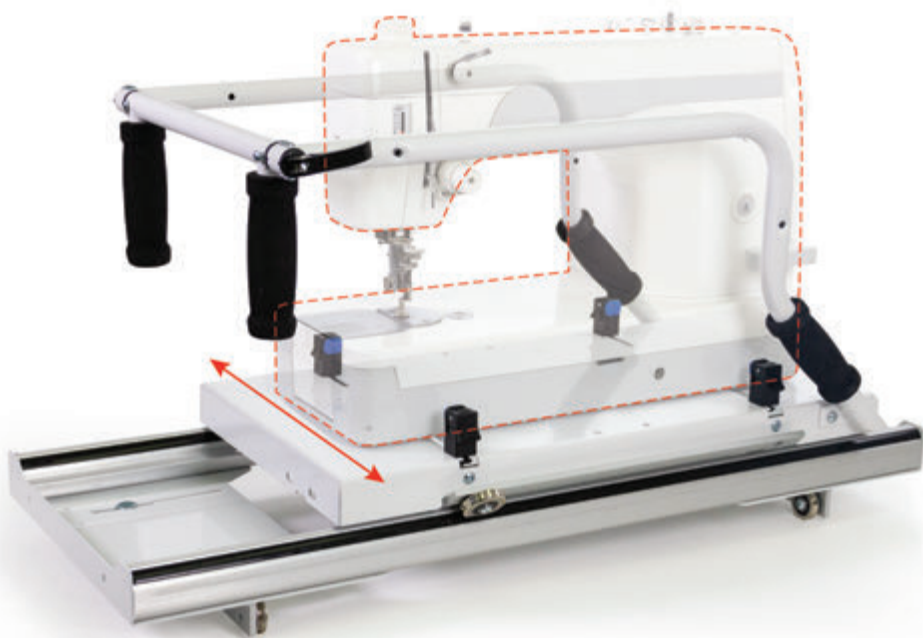

Maximum size of domestic machines using the top-plate with the attached handles:

Width: 11.5 inches

Throat Length: 14 inches

Note: If you plan to use a Q'nique 15, 16X or 19X with this frame, you will not need the top-plate. The Q'nique will sit directly on the tracks of the bottom carriage.

SPACE SAVING QUILTING FRAME

With a small floor space of only 4½ feet, The Q-Zone Hoop-Frame takes up less room than other quilting frames, while still letting you quilt any size quilt you want!

SIZE COMPARISON



ANY SIZE QUILTS

With the Hoop-Frame, you quilt one “zone” of your quilt at a time. The size of your quilt is not limited by the size of your frame, so you can quilt **any size**, even larger than king!

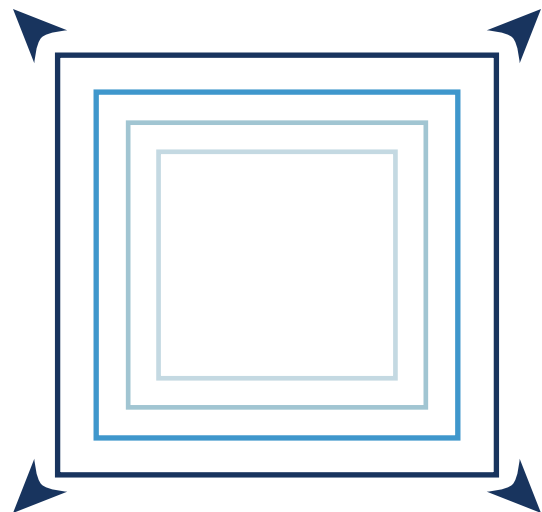

HEIGHT ADJUSTABLE LEGS



ADJUSTABLE LENGTH

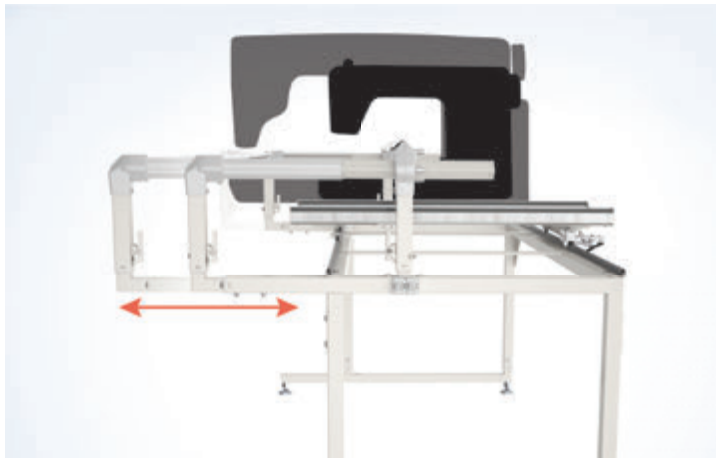

FEATURES

- Work sitting or standing
- For most any quilting machine
- Make quilts of any size
- Space-saving size
- Height-adjustable
- Budget-friendly

WHAT OTHERS ARE SAYING

“Working on the second quilt on my Hoop-Frame with my Q’nique 19! I’m loving this setup, and feel like adjusting my quilt is really not hard at all!”

—Jenifer F.

“Great product, perfect size. Very versatile”

— CATHY C.

OPTIONAL ACCESSORIES

TABLE INSERTS \$119.95



HOOP-FRAME EXPANDABLE HANDLES \$99.95



Perfect for machines with larger throat spaces. Use this if your machine has a throat length from 12 to 16 inches.

Q-Zone Queen Frame

\$1,899.95

The Q-Zone Queen Frame offers a high-quality machine quilting frame at an affordable price. This is a user-friendly 2 rail system and features included Quilt Clips, which make fabric loading and tension control easier.

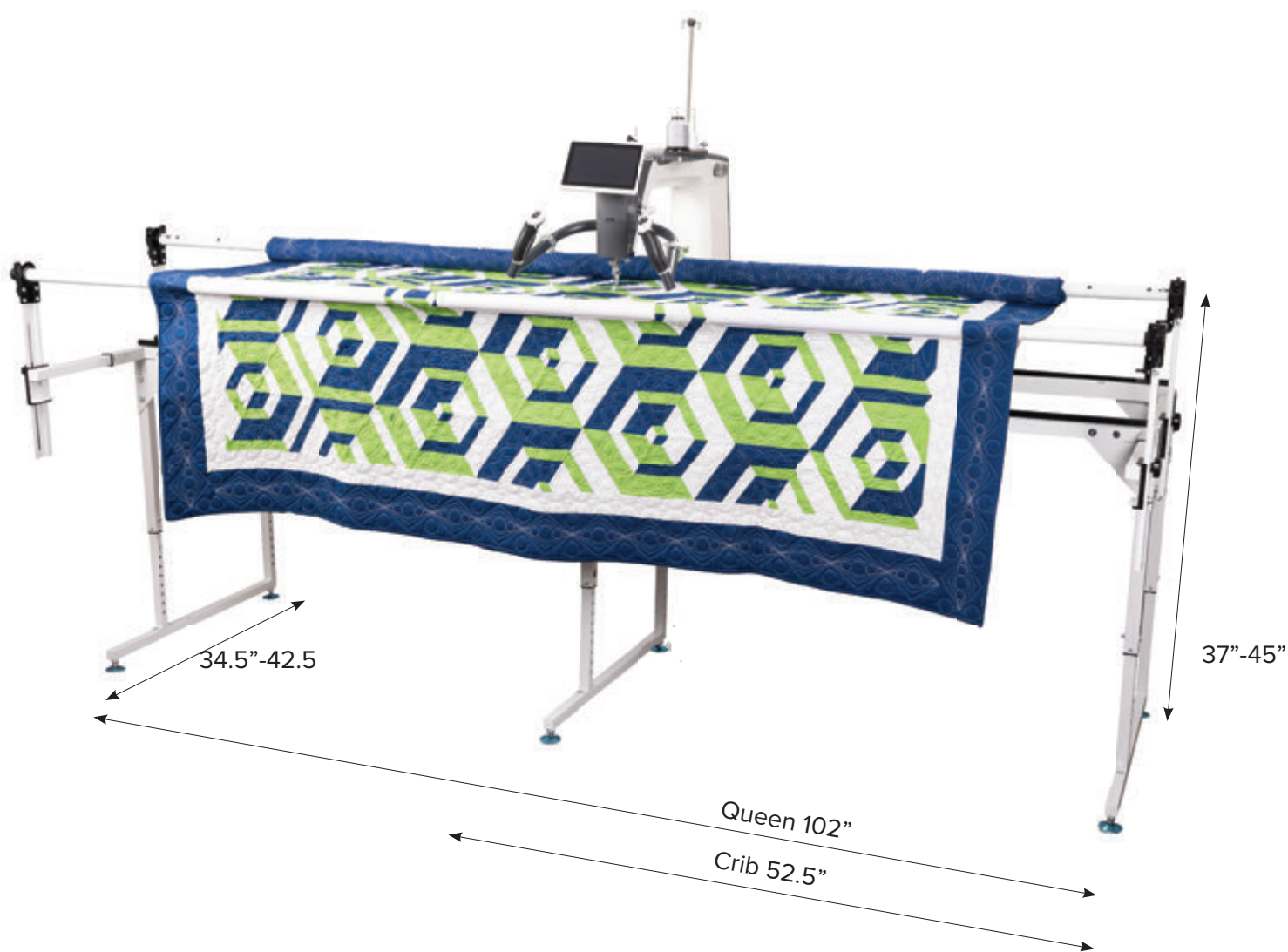

INCLUDED QUILT CLIPS



SMOOTH CARRIAGE SYSTEM

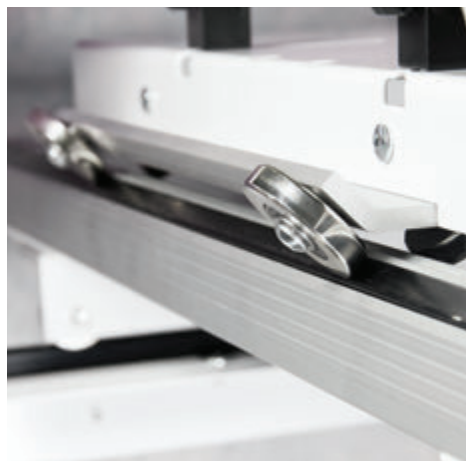

WORK SITTING OR STANDING



FEATURES

- Can be set up in queen (84") or crib (38") work areas
- Fits machines with up to a 19" throat
- Steel construction
- Set of four Quilt Clips
- Set of four Bungee Clamps
- Easy assembly
- Smooth dual-wheel track
- Leveling feet

OPTIONAL ACCESSORIES

TABLE INSERTS \$179.95

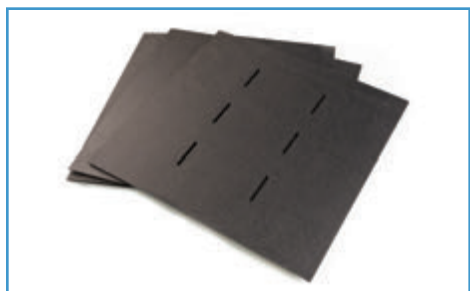

WHAT OTHERS ARE SAYING

"Very nice frame, makes quilting more fun."

—CAROL S.

"Very simple instructions. Very sturdy and can't wait to use it."

—Barbara S.

Quilter's Evolution Hoop-Frame

\$2,699.95
+ Shipping & Handling

This innovative new hoop-style frame provides the flexibility to create any size quilt with zone quilting paired with stronger, sturdier design that makes managing your fabric easier than ever.



EASY TO UPGRADE

The Evolution Hoop-Frame is part of the all-new Evolution frame series, allowing you to easily upgrade to the Evolution Elite frame as you continue to evolve your quilting.



HANDWHEEL ATTACHMENT

Want the simplicity of a rolling frame? The included handwheel can be attached in moments to quickly transform the Evolution Hoop-Frame into a two-rail rolling frame for smaller projects.

TAKE-UP RAIL CLAMPS

Redesigned take-up rail clamps remove the straps and make it even easier to manage excess fabric as you shift your quilt on your frame.



Quilter's Evolution Elite-Frame

\$4,299.95
+ Shipping & Handling

The Quilter's Evolution Elite makes rolling even the largest of projects a great experience. With a stronger, sturdier design and ratcheting rails, you'll enjoy complete control over your projects.



CHOOSE YOUR SIZE

The modular design of the Evolution Elite frame allows you to choose from sizes including 8', 10', and 12', so you can get the frame that best fits your space.

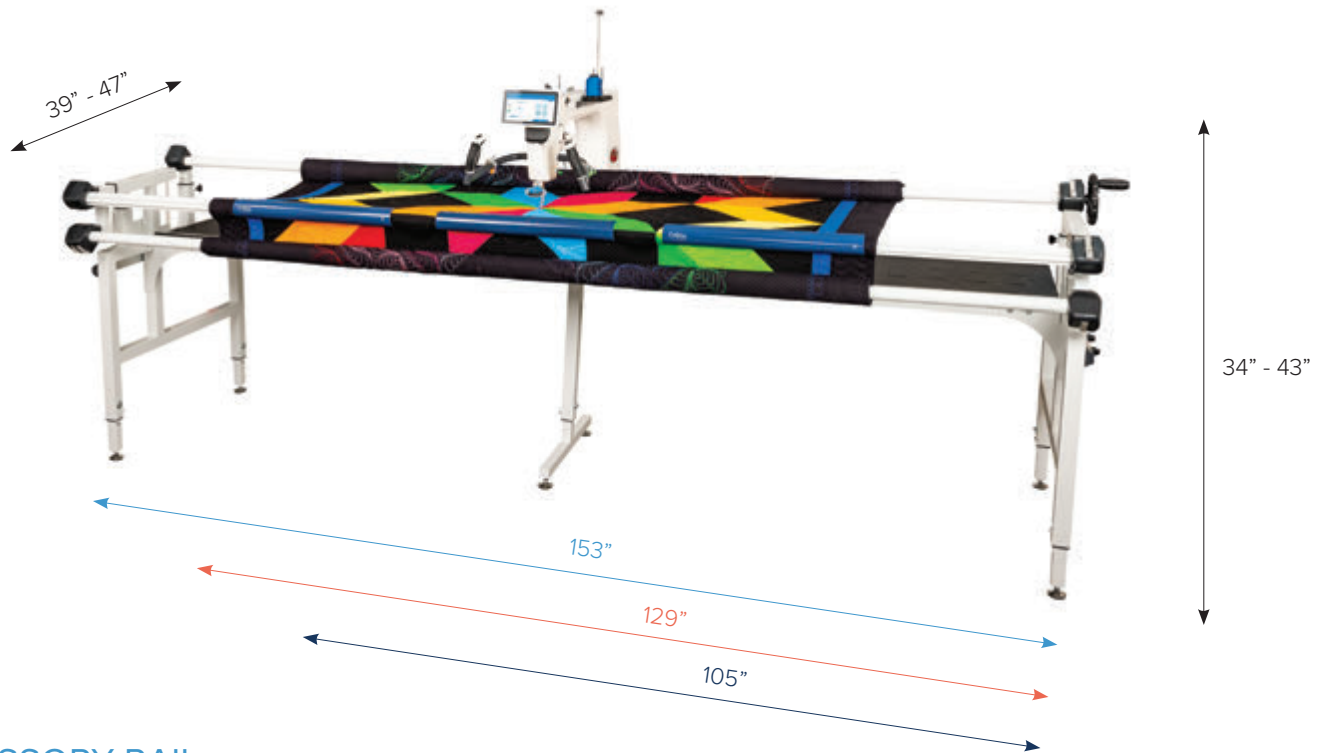

ACCESSORY RAIL

The optional accessory rail can be used as either a batting rail or an idler rail, giving you even more control over your fabric.

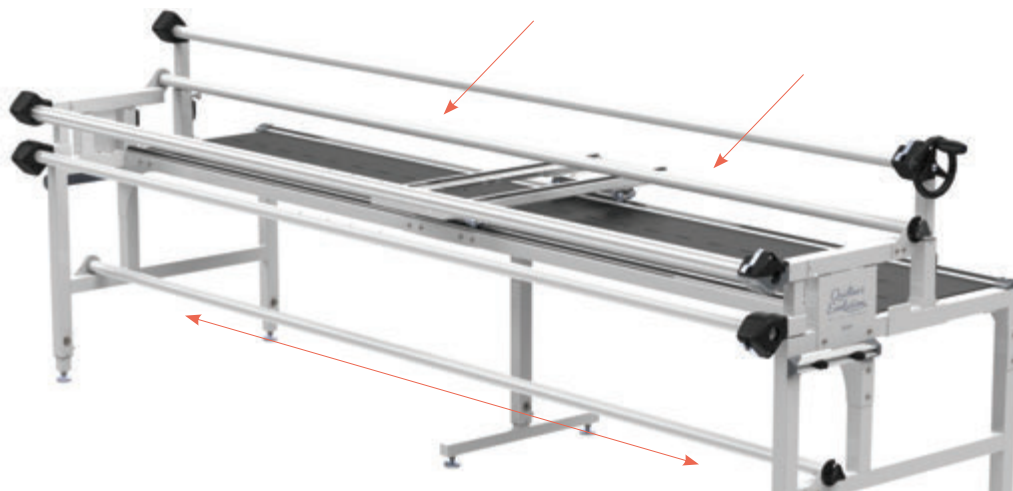

Continuum II Quilting Frame

8', 10', or 12' Continuum II Frame
\$2,999.95

The Continuum II frame is available in an 8 foot, 10 foot, or 12 foot model. With steel and cast-alloy components, the frame is one of the sturdiest and longest-lasting frames ever designed. This modular frame has many configurations and accessories. The Continuum accommodates all the Q'nique machines, as well as many other machines on the market.

WHAT OTHERS ARE SAYING

"Getting the Continuum II with the idler bar (is the best decision I've made! No wrestling with adjusting the height of the quilt means one less tension issue to contend with."

—DIANA B.

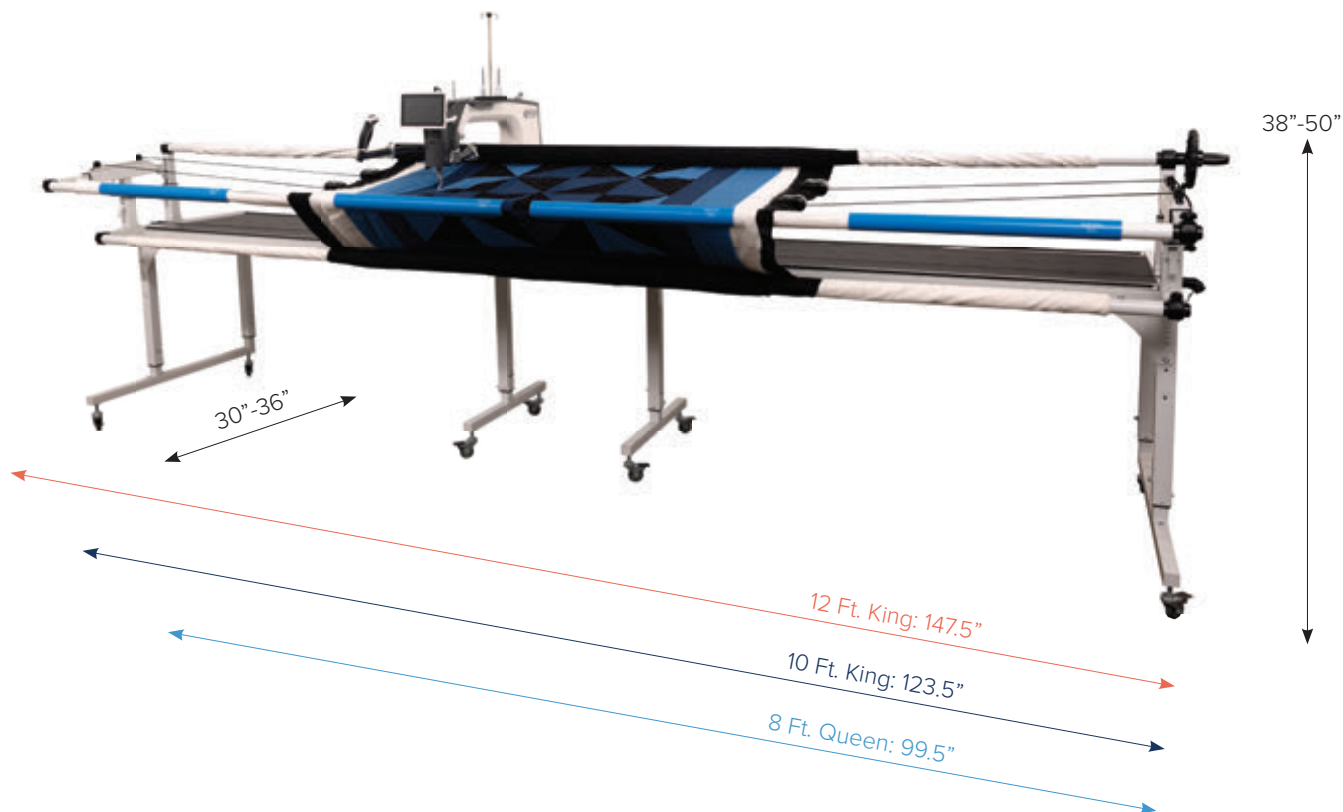

ADJUSTABLE DEPTH

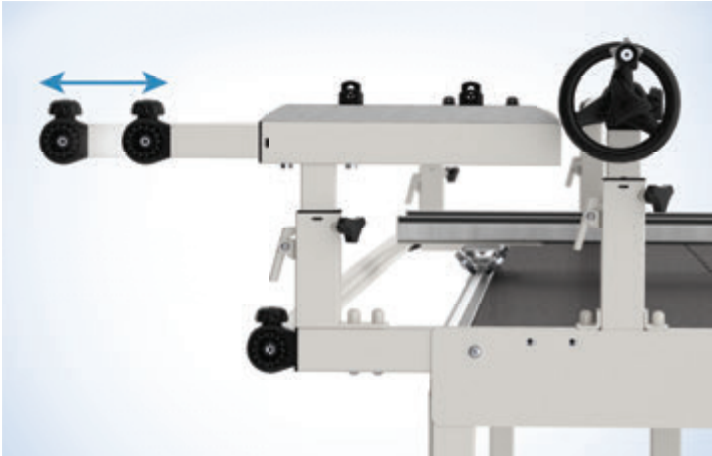

RATCHETING LOCKING RAILS

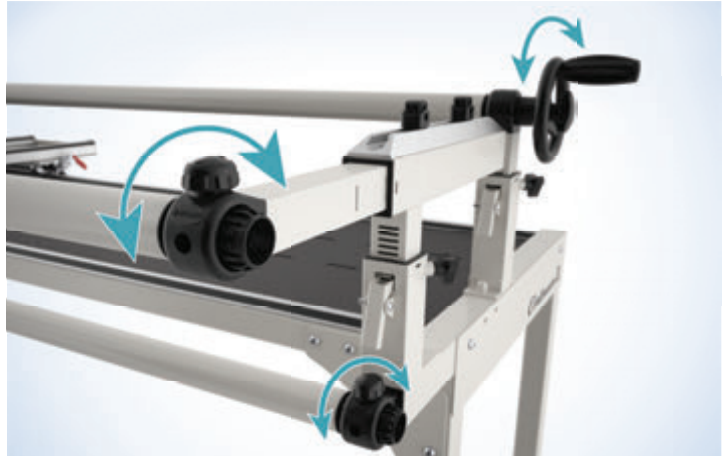

FEATURES

- 10 Foot model can be set up in king (123.5”) or crib (63.5”)
- 8 Foot model can be set up in queen (99.5”) or crib (51.5”)
- 12 Foot model can be set up in extended king (147.5”) or any of the other sizes
- Fits machines with up to a 21” throat
- Channel locks for easy straight lines
- Steel construction
- Dual-wheel track system for improved carriage motion
- Height-adjustable legs
- Leveling feet

OPTIONAL ACCESSORIES



BATTING RAIL

\$249.95



IDLER RAIL

\$299.95



TWO FOOT EXTENSION

\$699.95

Grace Hoop² DM

Hoop² DM Lap Hoop only **\$139.95**

Hoop² DM Hoop and Stand **\$299.95**

While other companies make hand hoops that are good enough, the Grace Company strives to be the best, which is why the Grace Hoop² DM is a truly unique and innovative hand quilting hoop that gives you better fabric management with added convenience, all while reducing unnecessary stress on the body.

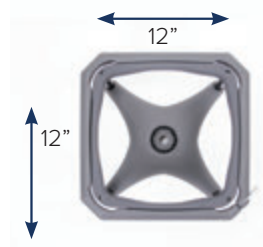

Perfect Size for Your Lap.



Pivoting Hoop for Easy Quilting



Adjusts to Fit Any Height Needed.



Tension Knob Holds Fabric Tight



Feet Fit Under Most Furniture.



Accessory Tray for Scissors, Thread, Etc.

A NEW GENERATION OF HAND QUILTING

As The Grace Company grows throughout the years, we continue to keep our eye toward the future of quilting and what that may hold; however, we must never forget the roots of quilting, which of course is hand quilting.



ADDED CONVENIENCE

The Grace Hoop² DM is the only hand quilting frame on the market that not only has an easy-to-use height adjustment but also a swiveling hoop. This allows you to quilt from the position most comfortable to you, reducing stress on the back and neck.

ORTHOPEDIC NEEDS

With its low-profile legs and effortless height adjustment, you'll never again have to worry about trying to get comfortable while quilting. When quilting somewhere where the stand just won't fit, simply detach the hoop from the stand. You can now have a frame that fits comfortably in your lap.

Quilter's Creative *Touch 5* ✨ PRO



QuiltMotion Quilter's Creative Touch 5 Pro
\$7,499.95



QuiltMotion Quilter's Creative Touch 5 Pro

Quilter's Creative Touch 5 is the latest version of QuiltMotion, the top-of-the-line automated quilting system. The ability to create, design, and quilt with absolute precision is right at your fingertips.

Let QuiltMotion do all the stitching for you! Get the perfect pattern, stitched exactly how you imagined it, every time! Even the most intricate and detailed patterns are stitched with the highest levels of quality using QuiltMotion Quilter's Creative Touch 5.

Quilt your masterpiece with ease using your favorite patterns from the included pattern library, or design your own.

See page 98 for a feature comparison of all the different QuiltMotion QCT5 tiers.

SEE HOW IT WORKS!



<https://bit.ly/QCT5-Pro>



IMAGINE AN AFFORDABLE, FULLY-FEATURED
COMPUTER AUTOMATED QUILTING SYSTEM
IN YOUR OWN HOME!



EASY USER-FRIENDLY DESIGN

QuiltMotion Quilter's Creative Touch 5 Pro features a newly improved interface that's easier to use. The software works with touch-screen tablets, offering the freedom to design and modify patterns wherever you go!

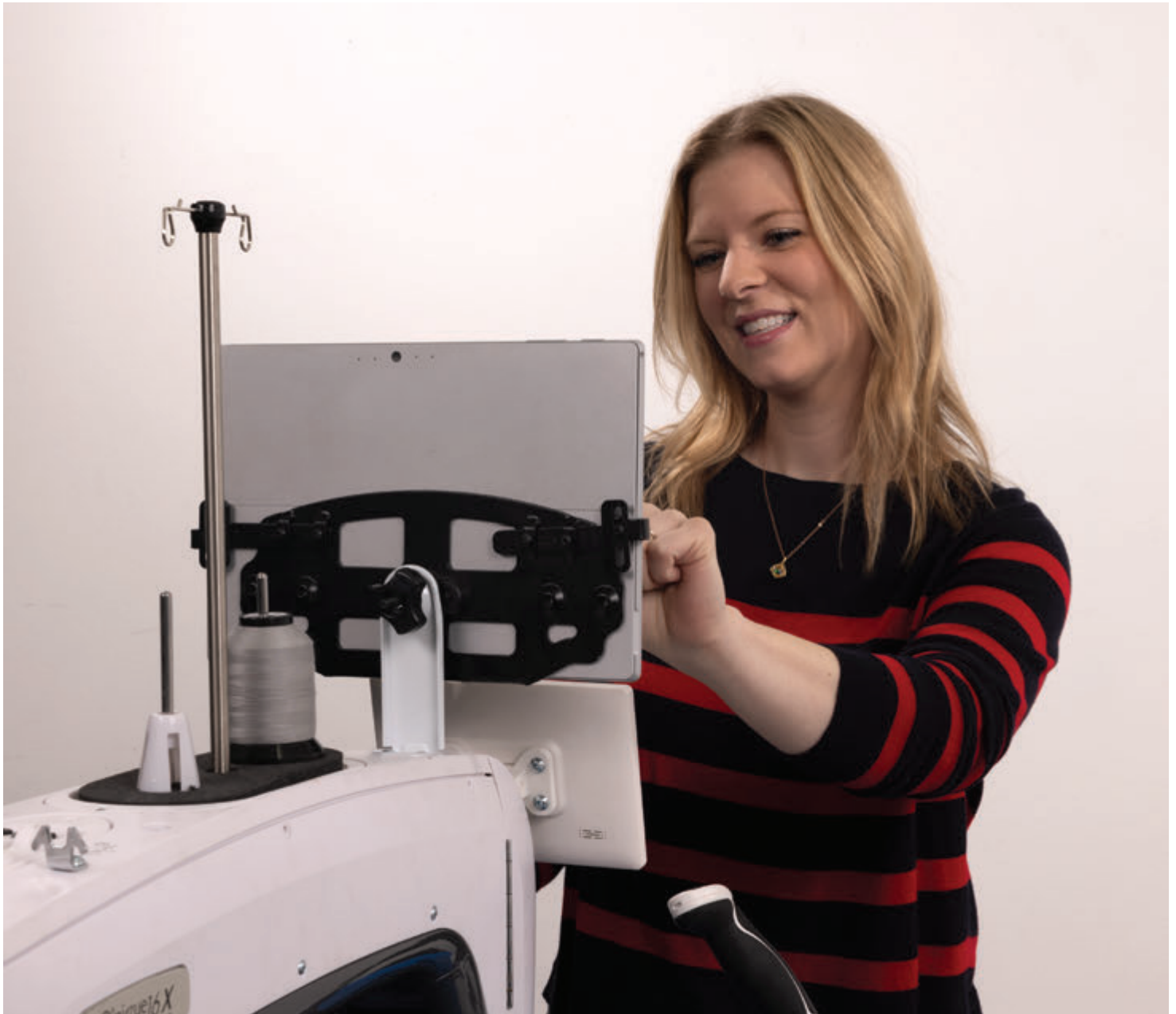

ADD AFFORDABLE, COMPUTERIZED QUILTING TO YOUR OWN HOME SEWING MACHINE



EASILY QUILT YOUR FAVORITE PATTERNS



You'll love seeing your favorite patterns and designs professionally quilted all by your own sewing machine.

A motor plate attached to the machine guides the sewing machine's motion for precise pattern stitching.

Let QuiltMotion QCT5 Pro do all the stitching for you and you'll get the perfect pattern, stitched exactly how you imagined it, every time!

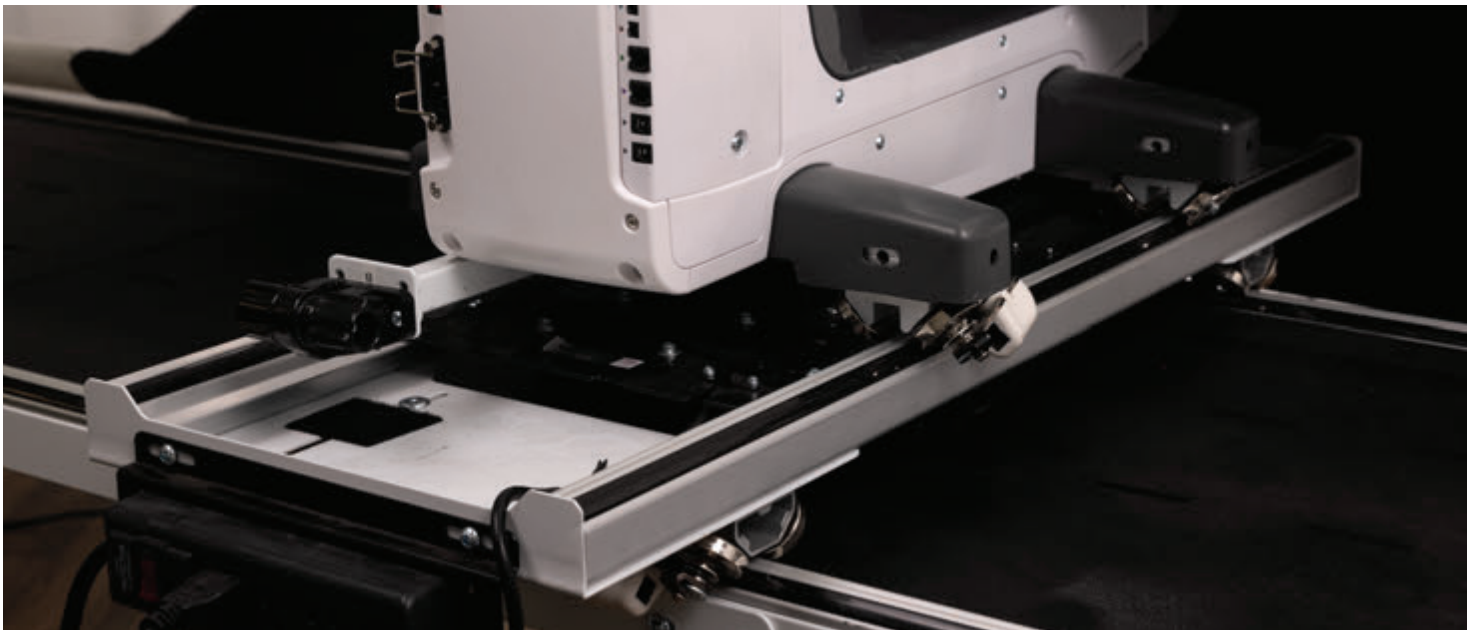

CREATE YOUR OWN DESIGNS

Even the most intricate, detailed patterns are stitched with the highest levels of quality with QuiltMotion Quilter's Creative Touch 5 Pro.

Quilt your masterpiece with ease. Use your favorite patterns or design your own.

The software can be installed on any tablet with Windows 7, 8, or 10*, giving you the freedom to design your own patterns or layout your quilt anywhere you want.

* For recommended tablet specs, see page 99



PERFECT PATTERNS IN 3 EASY STEPS

QUILTMOTION QCT5 PRO MAKES QUILTING YOUR PATTERNS AS EASY AS CAN BE



1. SELECT

Select from an extensive library of over 200 patterns or design your own.



2. PLACE

Place a sewing area on your quilt with your machine. The screen will show your pattern in relation to your placement and how it will really appear as sewn!



3. SEW

Quilter's Creative Touch controls your sewing machine to accurately stitch your patterns, exactly as you placed them!



ALL-INCLUSIVE SOFTWARE

ALL THE MOST POWERFUL QUILTING FEATURES, ALL IN ONE PLACE



POWERFUL FEATURES, POWERFULLY SIMPLE

QuiltMotion QCT5 Pro is a complete “flow-through” system for your entire quilting process. Pattern creation, design, editing, pattern placement and quilting are all contained in the same software.



OVER 200 INCLUDED PATTERNS

The included pattern library contains over 200 patterns from which to choose. Already have a digital library of your favorite patterns? You can even open patterns downloaded or purchased from other sources!

Patterns can be organized into blocks, continuous line pantographs, triangles, borders, and more!

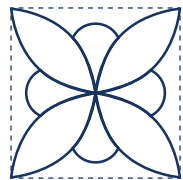

BLOCKS

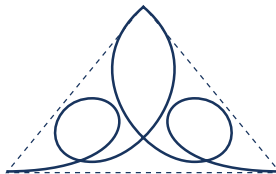

TRIANGLES

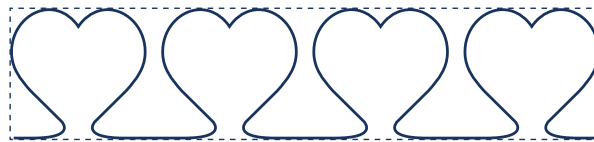

CONTINUOUS LINE

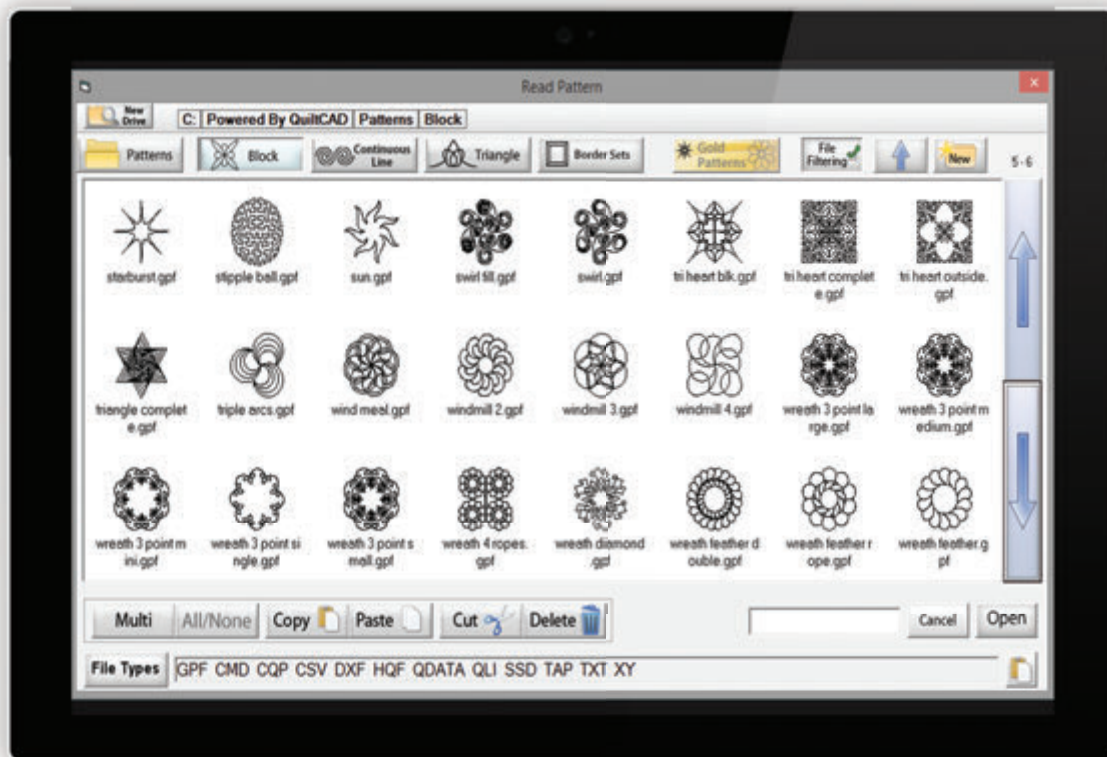

POSITION YOUR PATTERNS WITH EASE

Set your pattern on your quilt exactly how you want before having the machine quilt it for you. There are 7 different placement methods to choose from, so no matter the type or shape of your pattern, you'll be able to place it just right!

As you set the pattern area with your machine, the screen shows exactly how it will appear when sewn!

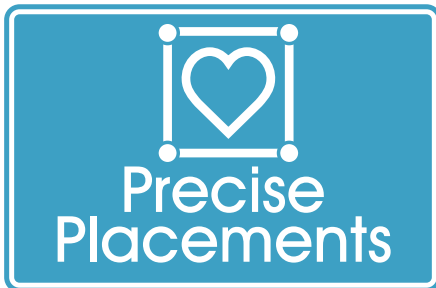

COMPLETE SIZING AND POSITIONING CONTROL

QuiltMotion QCT5 makes it easy to adjust your pattern placement with simplified rotation, flipping and other placement controls.

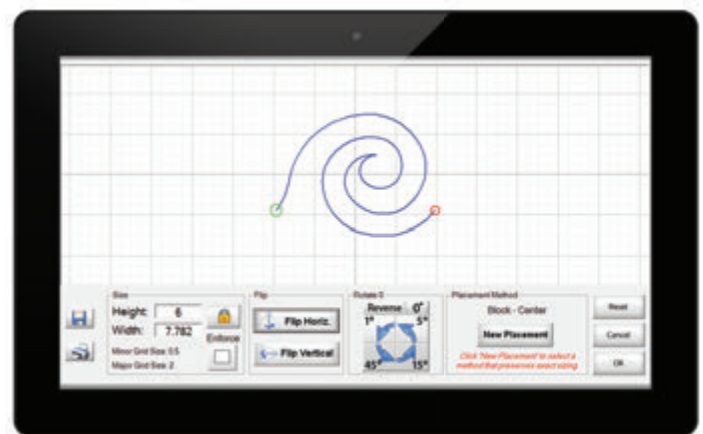

EASILY CREATE CONTINUOUS LINE PATTERNS





PantoStacker is the easiest way to create and edit pantographs. Create row after row of continuous line patterns that can be used to sew an entire quilt!

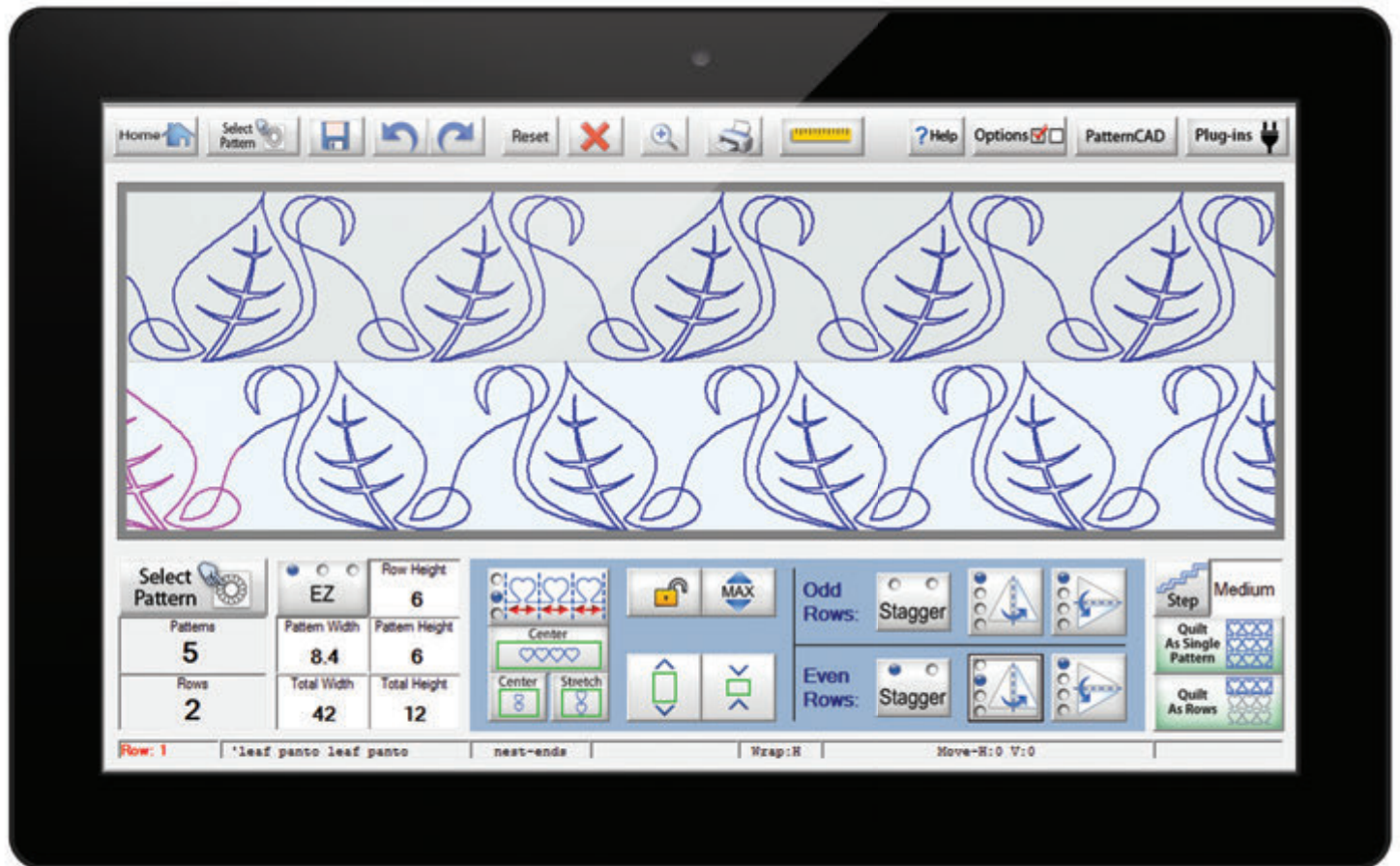

The PantoStacker feature is as basic or advanced as you need. Getting a pantograph on the quilt can be as easy as select, place, and sew. Get maximum control of the patterns in your pantograph with features like rotating, mirroring, alternating, off-setting, and more.

PATTERNCAD

Easily create the perfect pattern with the PatternCAD Feature. You can edit any of your saved patterns, or start completely from scratch. With PatternCAD, the only limit is your imagination.

LET'S GET CREATIVE



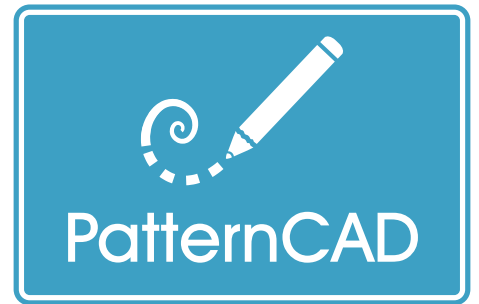

THE ULTIMATE TOOL FOR EASILY DESIGNING YOUR OWN PATTERNS



Make your favorite photos become your favorite patterns! Import any photo or image into PatternCAD and trace a pattern from it to use on your quilt.



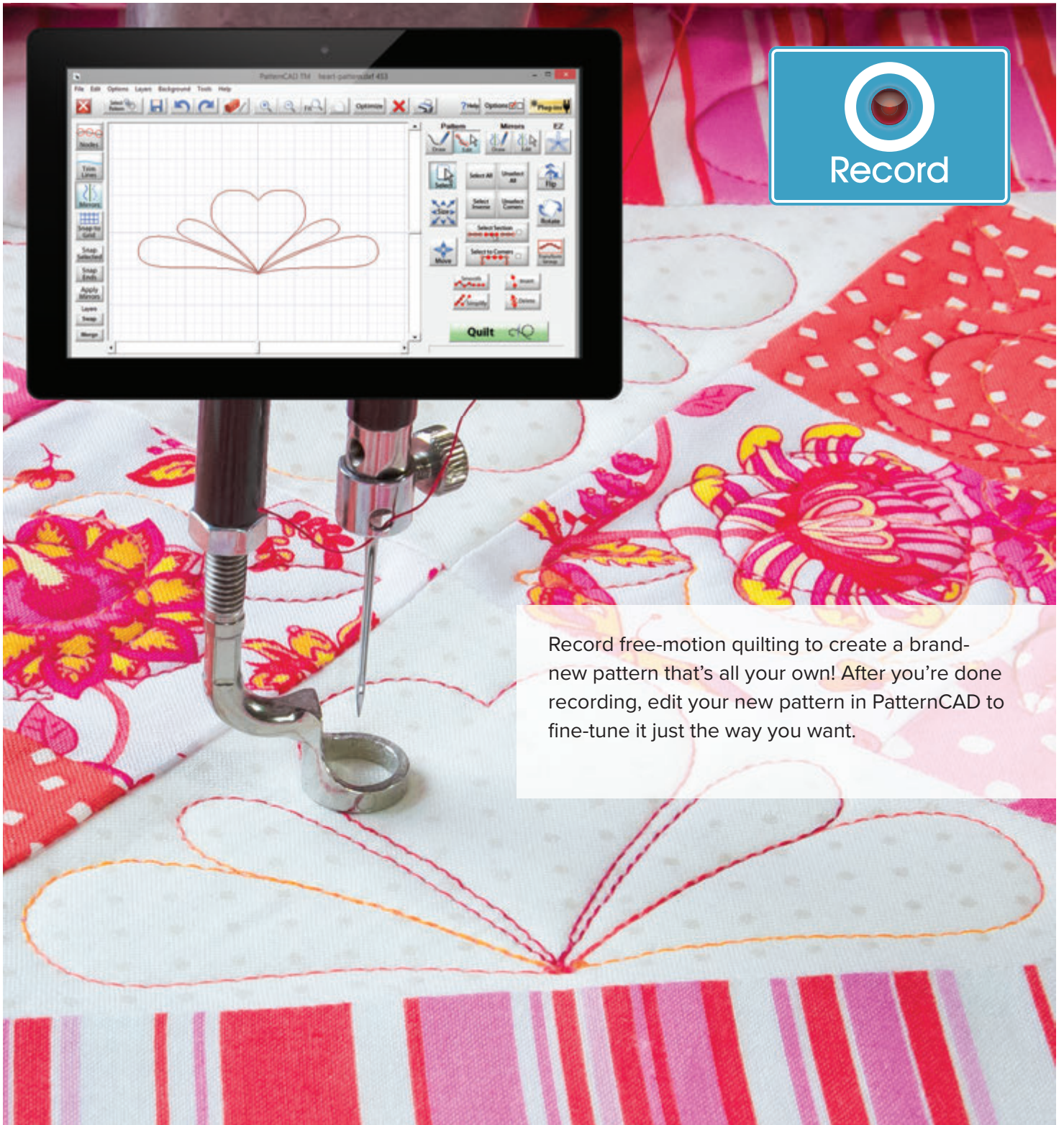

Record free-motion quilting to create a brand-new pattern that's all your own! After you're done recording, edit your new pattern in PatternCAD to fine-tune it just the way you want.

QuiltMotion Quilter's Creative Touch 5 Beginnings

DISCOVER YOUR INNER QUILTER

QCT5 Beginnings \$4,999.95

Looking to get computerized quilting at an even more affordable price?

QuiltMotion QCT5 Beginnings is a budget-friendly automated system that offers the essential features of computerized quilting. Just like the full version of Quilter's Creative Touch, the Beginnings tier lets you create your masterpieces in steps as simple as select, place, and sew.

QCT5 Beginnings

The Beginnings tier is the perfect introduction to computer automated quilting. Select patterns from the included library, and easily place them on your quilt for sewing. If you ever decide to take the next step and start designing your own patterns, an upgrade option to the fully featured QCT5 Pro tier is available.

See page 98 for a feature comparison of all the different QuiltMotion QCT5 tiers.

WHAT OTHERS ARE SAYING

"This software makes my quilting very professional-looking and it is easy to use."

—JANICE M.



QuiltMotion Quilter's Creative Touch Gold Access

QCT Gold (1 Year) \$199.95

GET THE MOST OUT OF QCT5 PRO WITH GOLD CARD ACCESS™

Gain access to everything Quilter's Creative Touch 5 Pro has to offer by purchasing **Gold Card Access**. Think of Gold Card Access as a key that unlocks additional benefits and powerful features beyond the standard QCT5 Pro tier.



Purchasing **QCT5 Gold Card Access** takes your quilting to a whole new level, with new exclusive creation tools and features. Get advanced control over pantographs, borders and corners, font stitching, and more!

All Gold Card Access holders also receive premium extras and benefits like exclusive patterns and more!

***Note: In order to activate QCT Gold, you must already own QCT5 Pro (not Beginnings).**



SEE HOW IT WORKS!



<https://bit.ly/qctgold>



GOLD CARD ACCESS BENEFITS

Access to special patterns only available to Gold Card holders.

Gold Card Access newsletter for occasional promotions, discounts, and all the latest QuiltMotion news and deals.

Continued access to **any and every** new feature and any software upgrades and updates.

Purchase of a **QCT Gold Card** unlocks all of the Gold Card Access benefits for one year after time of activation. Purchasing and activating another Gold card at any time will add an additional year to the time of your Gold Card Access.

If your time of Gold Card Access expires, you will lose access to **Gold-Only** features and benefits until you activate a new Gold Access Card.

See page 98 for a feature comparison of all the different QCT5 tiers.

BORDERS AND CORNERS™

FRAME YOUR QUILT LIKE THE MASTERPIECE IT IS!



- Create a beautiful border in just a few clicks!
- Customize your borders by mixing and matching different patterns for the center, border-fill, and corners.
- Fine-tune your borders by mirroring or changing the direction of the border patterns. Resize or rotate the corners, and choose how each pattern connects to the next.

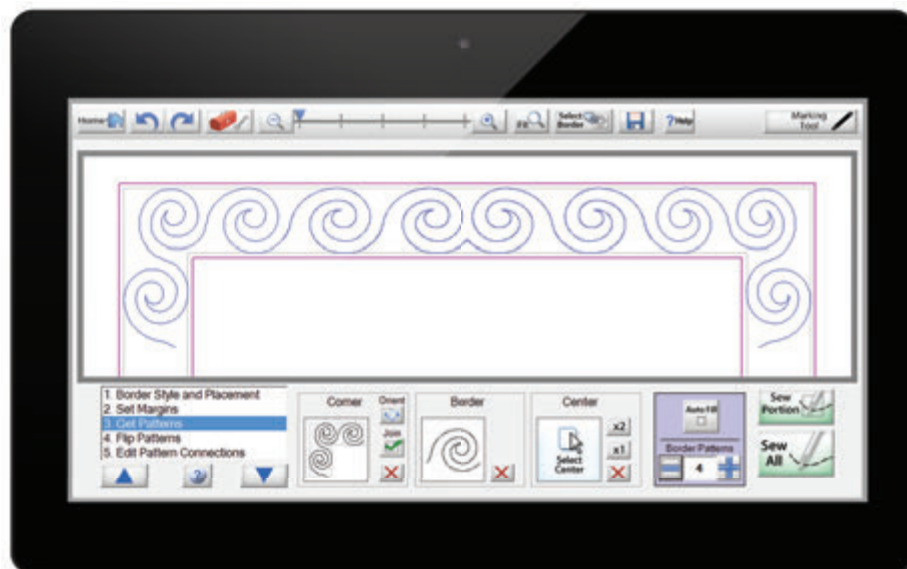

DIFFERENT CORNER STYLES AVAILABLE

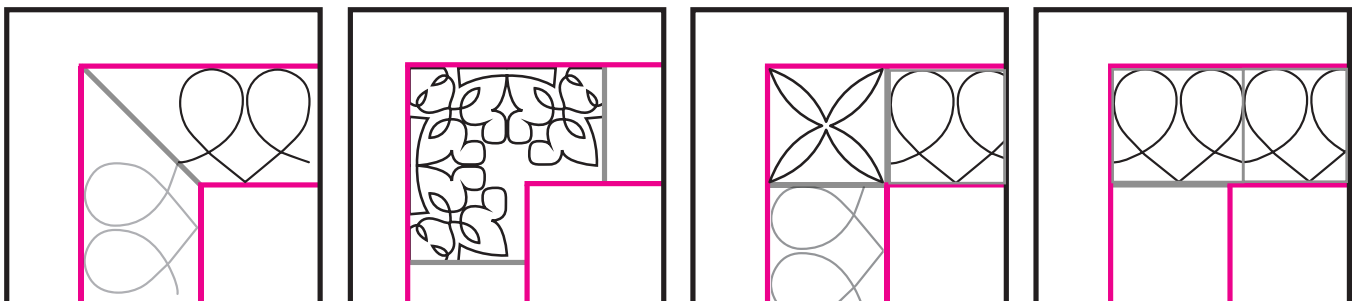

VIRTUAL LONGARM

EXTEND YOUR REACH

Now you can quilt those bigger, out-of-reach patterns, no matter the throat size of your sewing machine! **Virtual Longarm™** will take your oversized pattern and split it up into quiltable zones based on your machine's throat size.



ANY SIZED PATTERN, WITH ANY SIZED MACHINE



FONT STITCHER



THE WHOLE ALPHABET AT YOUR FINGERTIPS

Use any fonts installed on your system to add text to your patterns. Simply pick a font, type what you wish to say, and you'll have an amazing message ready to go on your quilt!

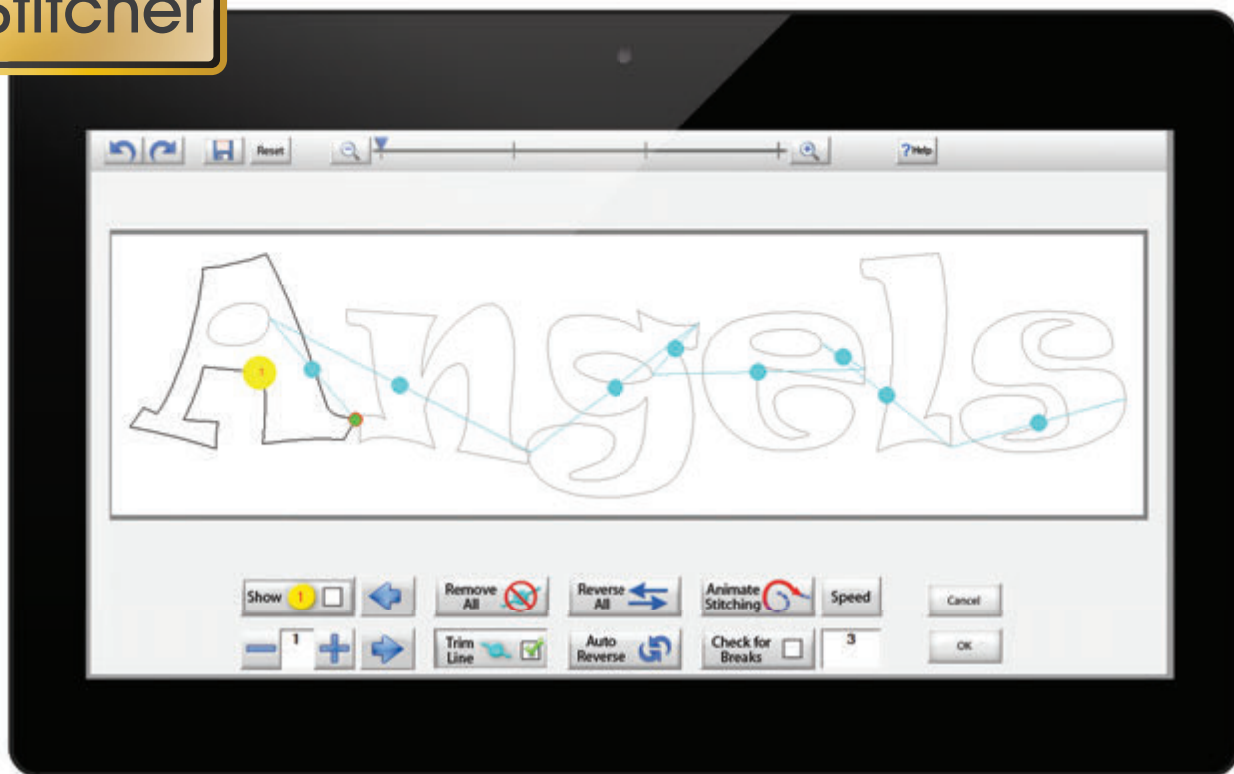

Feature Comparison

COMPARE THE DIFFERENT QUILTMOTION QCT5 PRODUCT TIERS

<i>FEATURE:</i>	QCT5* Beginnings	QCT5* PRO
Power Placement™: Easy pattern sizing, rotating, & flipping	●	●
PantoStacker™: Easy continuous rows	● (Limited)	● (Regular)
Easy edge-to-edge quilting	●	●
inForm: built-in tutorials, help, and tips	●	●
Rulers and centering	●	●
Export pattern to a different file type	●	●
Print any pattern or pantograph	●	●
Batch import & convert other file types	●	●
Marking Tool (capture points on fabric and see them on the screen)	●	●
Power Panto: Easy and powerful pantograph nesting options		●
Create & edit patterns with PatternCAD™		●
Design entire quilt layouts with QuiltCAD™		●
Record free-motion quilting as patterns		●
FEATURES WITH QCT* GOLD CARD ACCESS		QCT* GOLD
Borders and Corners™		●
Virtual Longarm™		●
Font Stitcher™		●
Pattern eClipse™		●
Multi-pattern placement		●
Advanced PantoStacker™		●
Corner Maker™		●
Fabric Compensation™		●
Gold pattern access		●

Using Your Own Windows Tablet



While compatible with any Windows home PC or laptop, Quilter's Creative Touch 5 Pro was specifically designed for touch screen tablets, so it can be used right at your sewing machine.

When deciding if your Windows tablet will work with Quilter's Creative Touch 5 Pro, here are some suggestions to keep in mind.

COMPATIBLE TABLET SUGGESTIONS

- QCT5 Pro will work on tablets running Windows 7, 8, or 10 or higher. **It will not work with Windows RT.**
- Your tablet should have a **full-size USB port** to plug into, even when your tablet is charging.
- The included tablet mount will hold tablets with screen sizes from **10 to 12 inches.**
- It is recommended that your tablet has **64GB** of total hard drive space or more, with **2GB** free for software installation, and **2GB of RAM** or more.
- You must have a 1.66GHz processor or higher.

Upgrade to QuiltMotion QCT5 Pro

STEPPING UP FROM AN OLDER QUILTMOTION VERSION



If you already own an older version of QuiltMotion, there is an easy way to upgrade to the latest version: **Quilter's Creative Touch 5 Pro**. Take the step up to the latest, most powerful, most user-friendly version of our automated quilting software now!

 **UPGRADE FROM OLDER QUILTMOTION VERSIONS**



UPGRADE PATHS TO QUILTMOTION QCT5 PRO

<p><i>UPGRADE FROM ORIGINAL</i></p> <p>QuiltMotion (8-Button Touch)</p>	<p><i>UPGRADE FROM OLDER</i></p> <p>QCT4</p>	<p><i>UPGRADE FROM CURRENT</i></p> <p>QCT5 Beginnings</p>
		
<p>Upgrade to a touch-screen tablet mounted right on your machine! Get all the new software features right at your fingertips.</p>	<p>Going from QuiltMotion QCT4 to the new QuiltMotion QCT5 is a simple process of upgrading your software through the help menus.</p>	<p>Upgrading from QCT5 Beginnings to QCT5 Pro adds many new features like pattern creation and editing, as well as adding complete control of your quilting process.</p>
<ul style="list-style-type: none"> • Purchase an upgrade kit, containing extra hardware in addition to the software. • A Windows tablet is not provided. See page 99 for tablet requirements. 	<ul style="list-style-type: none"> • Free software upgrade. • Begin the upgrade process right from the help menu in your Quilter's Creative Touch software 	<ul style="list-style-type: none"> • Purchase an upgrade package, containing the new software on a USB drive. • Unlock new features, including power to create and edit your own patterns.
<p>Call for pricing</p>	<p>FREE</p>	<p>Call for pricing</p>

Machine And Frame Compatibility

MACHINE COMPATIBILITY

QuiltMotion QCT5 Pro is designed to work with a large number of common quilting machines and quilting frames. It is compatible with domestic machines (shortarms), longarms, and midarms.

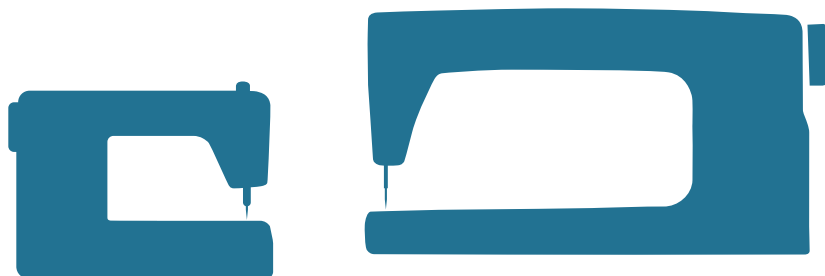

<p>BABY LOCK</p> <ul style="list-style-type: none"> • Crown Jewel • Crown Jewel II • Crown Jewel III 	<p>BERNINA</p> <ul style="list-style-type: none"> • Aurora Series • Artista 6/7 Series • Bernina 820 • Bernina 830 	<p>BLOCK ROCKIT</p> <ul style="list-style-type: none"> • Block RockiT 15 • Block RockiT 19 • Block RockiT 21/21 Pro 	<p>ELNA</p> <ul style="list-style-type: none"> • 7100 • 7200 • 7300
<p>JANOME</p> <ul style="list-style-type: none"> • 1600 (all versions) • 6500 • 6600 • 6700 • 9400 • HDR9 • Horizon 7700 • Horizon 8900 • M7 Continental 	<p>JUKI</p> <ul style="list-style-type: none"> • 98Q • 98QE • 2010 Q • 2000 Qi • 2200QVP Mini 	<p>Q'NIQUE</p> <ul style="list-style-type: none"> • All X series machines • Q'nique 15R • Q'nique 15 Pro • Q'nique 19 • Q'nique 21 • Q'nique 21 Pro 	<p>ECLIPSE</p> <ul style="list-style-type: none"> • EQ20

FRAME COMPATIBILITY

QuiltMotion Quilter's Creative Touch 5 Pro is compatible with all of the current Grace Company quilting frames and most of the past Grace quilting frames. ***It is important that you specify which frame and sewing machine you plan on using when you order your QuiltMotion QCT5 Pro.***

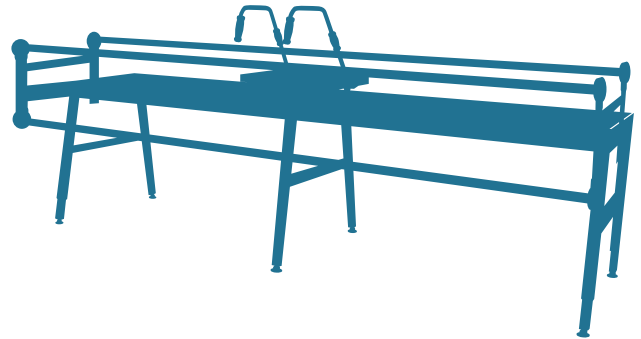

CUTIE TABLETOP FABRIC FRAME CONTINUUM & CONTINUUM II Q-ZONE QUEEN FRAME



Q-ZONE HOOP-FRAME

Q-ZONE HOOP-FRAME PRO

GQ FRAME



QUILTERS EVOLUTION HOOP-FRAME

QUILTERS EVOLUTION ELITE-FRAME



Other Compatible Frames

- Pinnacle
- GMQ-Pro*
- SR2 Frame
- SR2+ Frame
- Little Gracie II*
- Bernina Frame*
- Pfaff iQuilt
- Janome Artistic
- Launchpad Frame
- Q'nique Frame
- Gracie King/Gracie Queen
- Majestyce

*Must have the latest carriage to be compatible.

What's Included

INCLUDED IN EVERY QUILTMOTION QCT5 PACKAGE

- QCT5 software (with help files)
- Motor plate
- Tablet mount
- Belts
- All necessary hardware
- Screen cleaning cloth
- Tablet stylus
- USB cables
- Surge protector
- Quick install guide
- Cable taming kit



Specs & System Requirements

FILE TYPES

Already have your own collection of digital patterns? All QuiltMotion QCT5 tiers can open the following file types. The QCT5 Pro and Gold tiers can also export files into any of these file types.

- GPF
- DXF
- CMD
- CQP
- CSV
- HQF
- QLI
- TAP
- TXT
- XY
- Qdata
- SSD



RECOMMENDED SYSTEM REQUIREMENTS

- QCT5 will only work on devices running Windows 7, 8, 10 or higher. It will not work with any version of Windows RT.
- A 1.66 GHz. or faster processor is recommended.
- A device with a total of 64 GB hard–drive space is recommended, with at least 2GB available for installation.
- 2 GB or more of RAM is recommended.
- A full–size USB port is required. If your tablet uses a USB port to charge, it must have a second USB port to plug into QuiltMotion.
- Internet connectivity is necessary for registration, activation, and Gold Card Access benefits.
- Screen resolution of 1024 x 768 or higher.

OPTIONAL ACCESSORIES



QUILTMOTION BELT & CABLE MANAGEMENT KIT

\$49.95

This kit helps organize the various QuiltMotion cables and belts, keeps them from interfering with your quilting, and eliminates the friction that can occur when free motion quilting with an automation setup. It includes all the tools you need to manage your cables and keep them in one place, eliminating the frustrations of cables getting caught on your carriage or becoming unplugged during use.

Quilter's Creative Design Pro

Quilters Creative Design Pro \$399.95

No more spending money on expensive pantograph books and patterns! Use Quilter's Creative Design Pro to print custom-sized pantographs, blocks and entire quilt layouts from your home computer. The new user-friendly software makes quilt design easier than ever!

***This is a pattern design software
and will not connect to your
machine for automated quilting.***

Powered By QuiltCAD





FEATURES

- Create patterns, pantographs, and borders
- Design entire quilt layouts
- Print your designs on your home printer
- Included library of over 200 patterns
- Trace patterns from photographs
- PantoStacker: Quick and easy pantograph layout with powerful row placement options
- Font Stitcher: Use your computer's fonts in your pattern designs
- Virtual Longarm: Print larger patterns split-up to be sewn by machines with various sized throats
- Import and export patterns of different file types

Luminess LED Light Station

Small Model \$499.95

Large Model \$699.95

THE PERFECT LIGHTING SOLUTION FOR ANY WORK AREA

The Luminess is a free-standing, adjustable light station that is perfect for any project. Not only is it adjustable in height and length, but it can be easily rolled over any area. The low-wattage LED bulbs produce more light with less heat, and are color-balanced to reduce eyestrain.



ULTIMATE LIGHTING

The low-wattage bulbs produce more light while consuming less power, and putting off less heat than standard work lights.

Even after hours of use, the Luminess lights are cooler than either halogen or incandescent lights. The full Luminess also consumes less power than two regular 60 watt bulbs. A two foot extension is also available for the large model, to cover nearly 14 feet.



TRUE-COLOR BALANCED LIGHTS

Light quality is important when working for long periods of time. The Luminess offers the highest kind of quality in lighting, with special attention to the softness of the light and color balance.

The Luminess features a special **True-Color** balanced lighting system that's perfect for artists and crafters.

When you use a Luminess work light, rest assured that the colors you see are accurate, with no tinting or false-color casts. The True-Color lights also reduce eyestrain by minimizing glare and softening shadows, while enhancing details and textures.

WITHOUT BALANCED LIGHT



WITH TRUE-COLOR BALANCED LIGHT

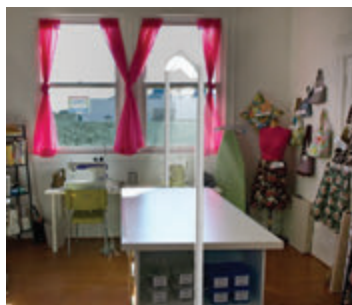

FEATURES

- LED light technology
- True-Color balanced for accurate colors
- Bright white color lamps
- Softer shadows
- Soft light for less glare/reduced eyestrain
- Free-standing for use over any space
- Caster wheels for easy mobility
- Height-adjustable
- Sturdy steel frame
- Low wattage (less power consumption)
- Low heat
- Simple on/off switch

DESIGNED TO FIT YOUR NEEDS

The Luminess can be fit perfectly over any project, quilting frame, or work area. It's also height adjustable, and has removable sections so it can be placed on top of your work area. The Luminess is available in a **Small Model** (perfect for areas up to 6 feet), or a **Large Model** (perfect for areas up to 11 feet). The large model can also be set up a medium or small size.



WHERE YOU NEED IT MOST

Have more than one work space in your sewing or craft room? The Luminess is easily wheeled right where you need it.



OPTIONAL ACCESSORIES

2 FOOT EXTENSION \$149.95

Only compatible with the large model Luminess. Extends your lighting to cover larger work areas.

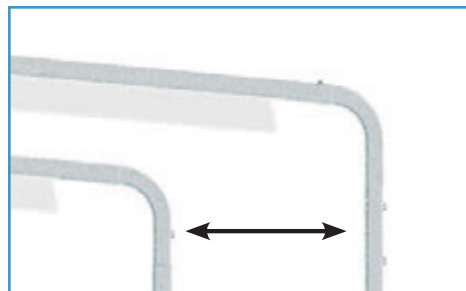

SPECIFICATIONS

The connectors between the top sections allow additional adjustment to the width.

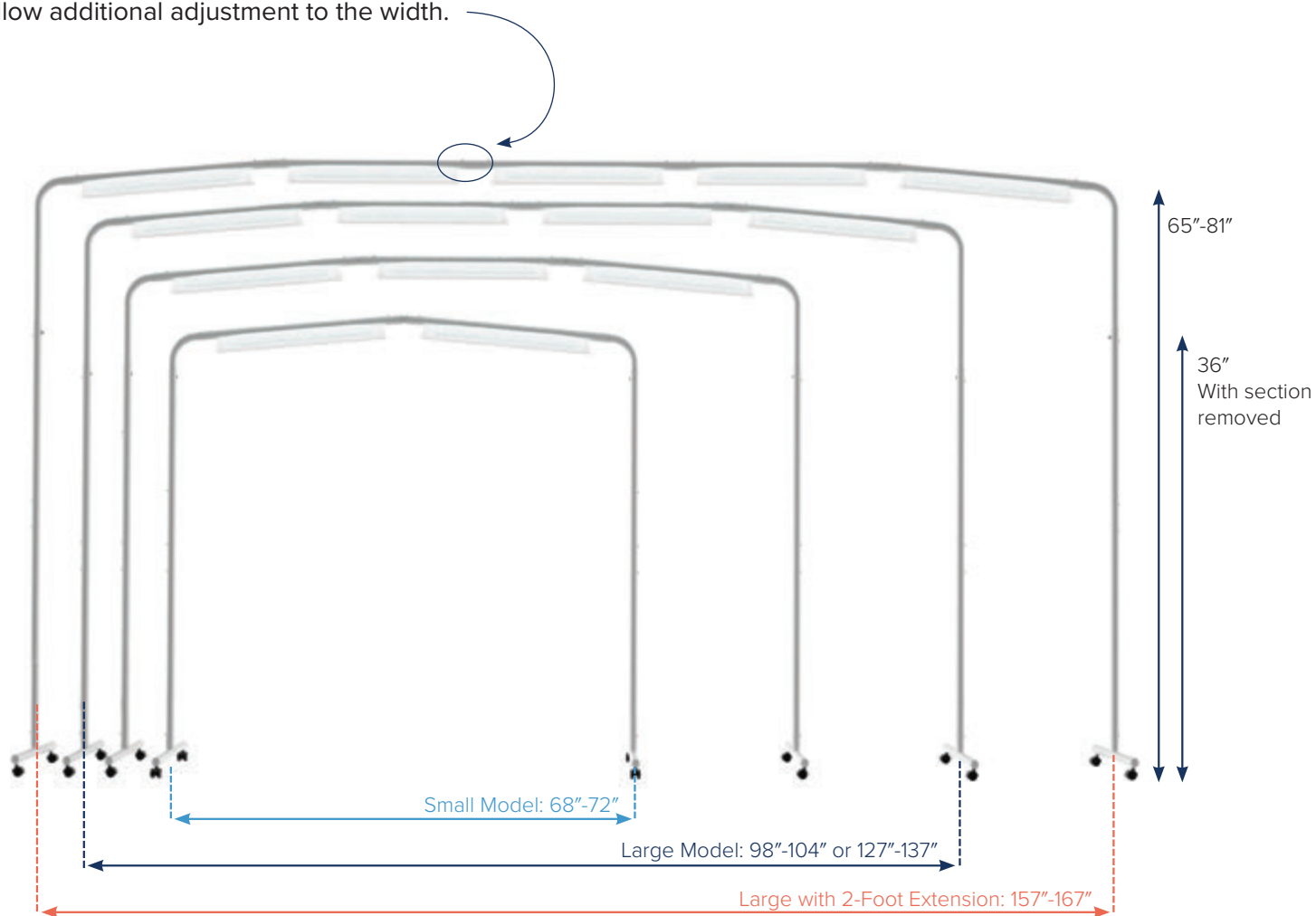

BULB SPECIFICATIONS

- Bulb type: Proprietary LED bulbs
- Power: 24 Watts (each bulb)
- Color: Bright-White (6400 K.)
- Brightness: 2150 lumens (each bulb)

SureStitch Stitch Regulator

SureStitch Stitch Regulator
\$599.95

The Grace SureStitch is both a stitch regulator and constant stitch speed control. In stitch regulation mode, it takes advantage of your machine's full range of speeds. As you speed up and slow down, the SureStitch adjusts your stitching speed, keeping your stitches more consistent.



- Easy controls at your finger tips: on/off, pulse, stitch length
- Dual-color LED display warns you when you exceed your machine's maximum speed

Call us or visit our website to see if your machine is compatible.



SureStitch Elite

SureStitch Elite
\$899.95

The SureStitch Elite is a sleeker, more intuitive version of the SureStitch you know and love. With a user-friendly touchscreen interface and exciting new features, this product adds a sense of intelligence and elegance to your machine.



- Touchscreen display adds a whole range of new customizations and options
- Customizable stitch length presets and minimum speed adjustment allow for improved stitch quality
- Edge warning feature helps keep your machine on track while stitching
- Measuring function and built-in calculator provide improved accuracy

Call us or visit our website to see if your machine is compatible.

SEE HOW IT WORKS!



<https://bit.ly/surestitch-elite>

Plastic Pattern Perfect Basic Set

Plastic Pattern Perfect Basic Set **\$289.95**

Get perfect patterns every time! The stylus guides your machine through the pattern templates as you quilt. Each original 12"x 8" template is double-sided and includes eight patterns. The Basic Plastic Pattern Perfect set comes with the stylus, all needed hardware, and enough templates to fill the length of your frame.

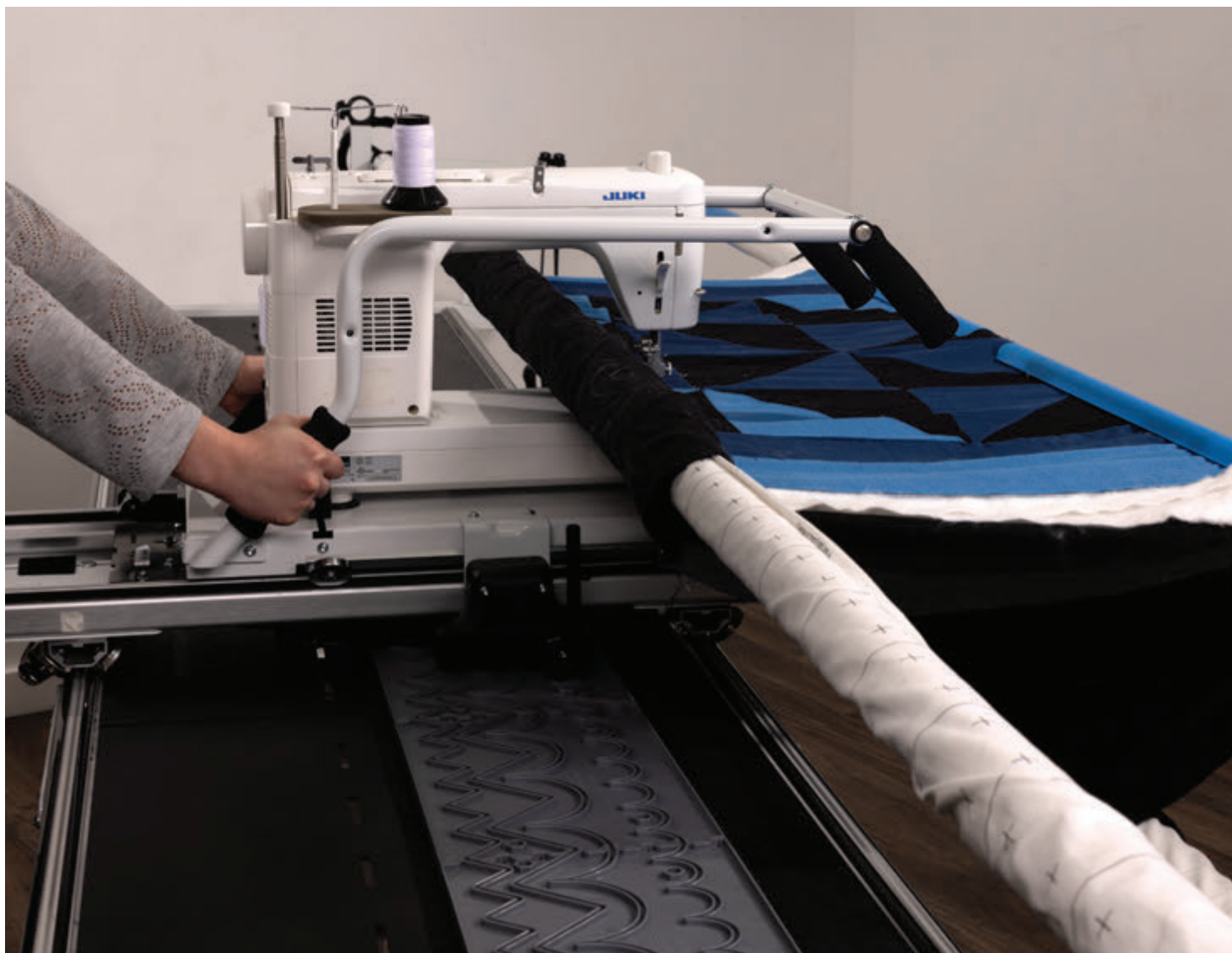

Plastic Pattern Perfect Three Panel Set \$129.95

Additional Pattern Templates

- Six pattern designs to choose from
- Works with existing Plastic Pattern Perfect basic set equipment
- Light-weight, easy-to-store

Each set contains three templates with the same pattern.

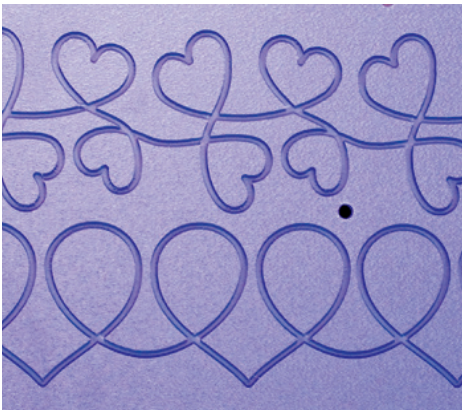

HEARTS

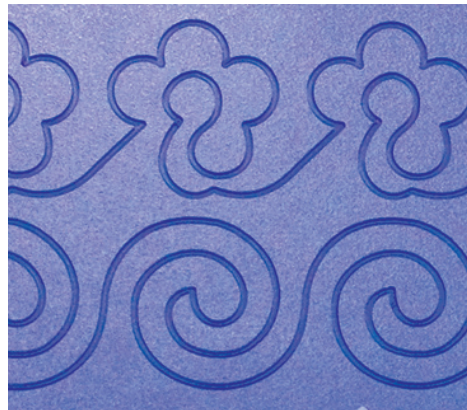

POPCORN-SWIRL

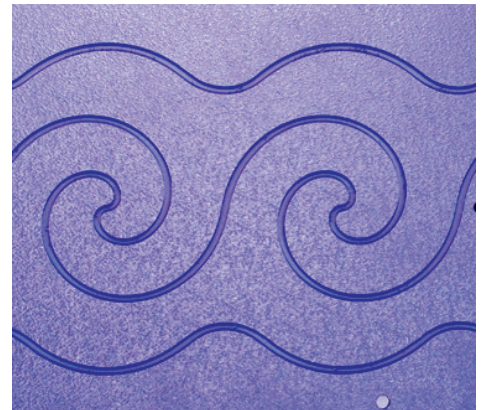

SPIRAL

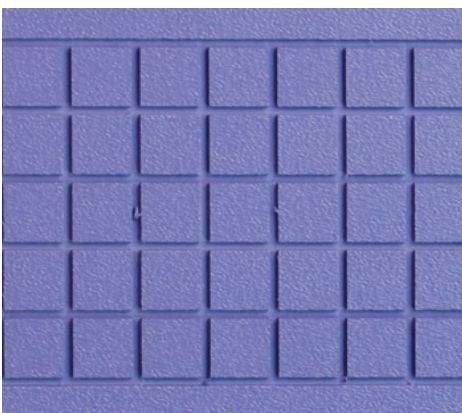

GRID

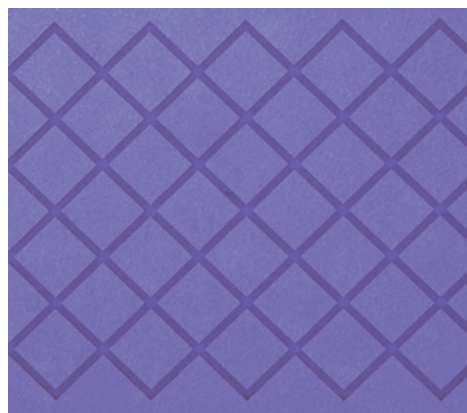

CROSS-HATCH



TULIPS

Free Motion Quilting Starter Kit

Free Motion Quilting Starter Kit \$149.95

The Free Motion Quilting Starter Kit is the perfect way to practice your free motion quilting skills. This starter kit contains a fabric quilt panel with fun practice designs that you can use with any quilting machine or frame. It also comes with paper tracing sheets for additional practice. You'll love seeing your free motion skills improve using the tools and resources within this kit.



GRACE STARTER QUILT PANEL

This practice quilt panel has a variety of designs to show you what you can do with free motion quilting. Backing fabric, batting, bobbins, and thread are also included so you can have the most accurate practice possible.

INCLUDED IN KIT

- Grace Starter Quilt Panel
- Free Motion Starter Guide
- Batting and Backing Fabric
- 2 Spools of Finesse 500 yd Thread
- 6 Tracing Practice Sheets
- 3 M Class Bobbins
- 3 L Class Bobbins
- 1 Tracing Pencil with Sharpener



FREE MOTION STARTER GUIDE

This handy starter guide has everything you need to know about free motion quilting from start to finish. It has instructions for most machines and frames and will help you get started on your free motion journey!

PAPER TRACING SHEETS

These tracing sheets are perfect for getting familiar with the different designs before you move on to quilting on the quilt panel. You can trace over these as many times as you want to make sure you memorize the pattern.

Gracie Laser

Gracie Laser \$49.95

The Gracie Laser can easily be attached to the front or back of your top plate carriage and is battery powered so cords won't get in the way! It is fully adjustable, and comes with four different laser tips to control the size of your tracing laser.



- Attaches to the front or back of your frame's carriage
- Fully adjustable swivel
- Battery powered (AA batteries not included)
- Cordless
- Four different laser tips to control the size of your laser



Note: This laser is not compatible with the Q'nique quilting machines. For a Q'nique compatible laser, please see our Q'nique laser stylus (see page 32.)

G-Series Carriage 2

G-Series Carriage 2 **\$349.95**

Upgrade to the G-Series Carriage! The dual-wheel Sure-Track system enhances motion makes quilting easier.

- Smooth gliding plastic track
- Precise and accurate movement for small, intricate stitching
- Soft comfort grip handles
- Base clamps to hold your sewing machine in place

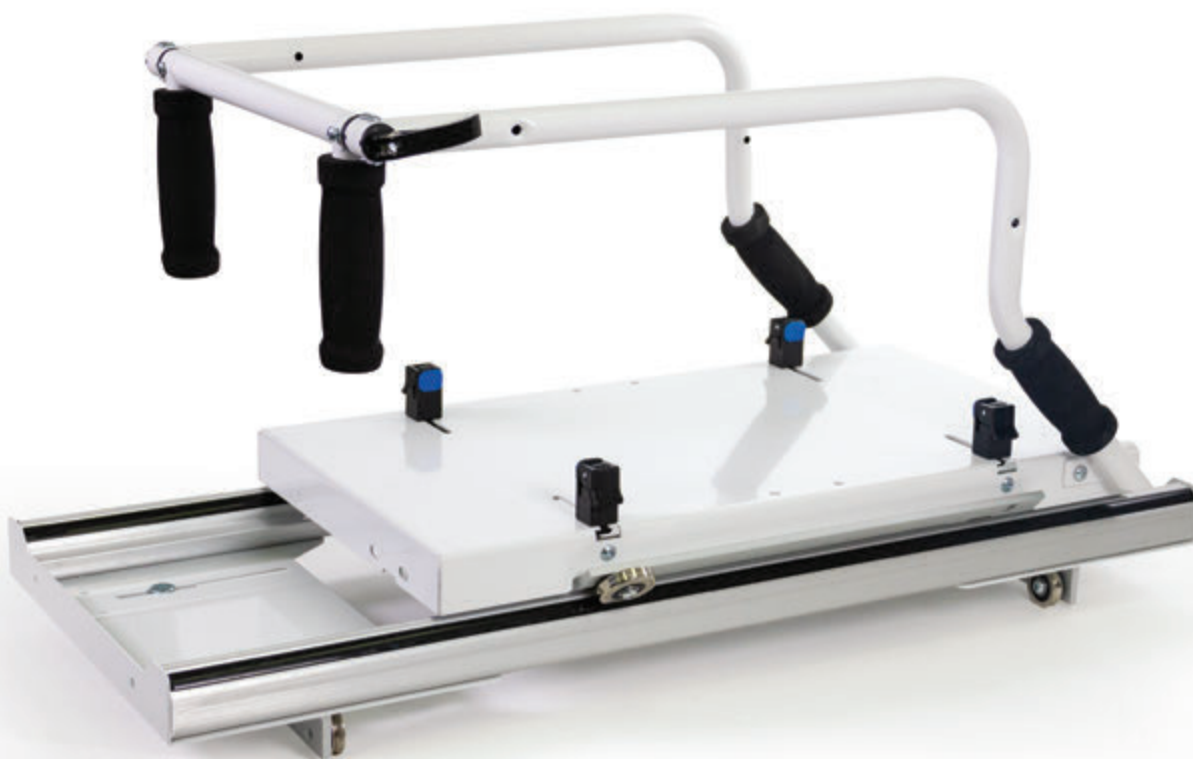

Grace Speed Control

Grace Speed Control \$79.95

The Grace Speed Control is a universal foot pedal replacement. Use the dial to set the speed of your sewing machine. It works with many machines on the market so if you switch sewing machines, the Speed Control can too!



- On/Off button to start and stop your machine
- Easy-to-use knob controls the stitching speed

Note: This controls the constant stitch speed, it is NOT a stitch regulator like the SureStitch.

Call or visit our website for a machine compatibility list.

Grace Company Quilt Clips

Grace Company Quilt Clips 1.5" or 2" Diameter
\$89.95

Designed for a new level of ease in machine frame quilting, Grace Company Quilt Clips let you make quick adjustments, so your fabric will always be straight and have perfect tension. Use the Quilt Clips to attach your fabric to your quilting frame with less pinning. Each package includes four Quilt Clips, each 24 inches long.

SEE HOW IT WORKS!



<https://bit.ly/quilt-clips>



Grace Company Mini Quilt Clips

Grace Company Mini Quilt Clips
\$19.95

While the Grace Company Quilt Clips were made for frames, the Grace Company Mini Quilt Clips were made for everything else! Designed to help organize your fabric on the table, your supplies, or whatever else you want to keep together, the Grace Company Mini Quilt Clips will take care of you.



Bungee Clamps

Bungee Clamps \$49.95

The new Grace Company Bungee Clamps have a sleek new profile to make attaching and removing them even easier! The Bungee Clamps provide excellent and even side tension for your quilts at the edges of your machine or hand quilting frame. All Grace frames currently come with a set of four.



Grace Company Cloth Leaders

A time-saving product to help you easily attach your fabric to your frame, each of the three cloth leaders are printed with precise guide marks and pin lines. Also included is a Velcro® attachment kit that can be used to secure the cloth leaders to your frame. Available specifically for Q-Zone Frames, or in two general sizes.



112 Inch Cloth Leader **\$189.95**
+ Shipping & Handling

136 Inch Cloth Leader **\$199.95**
+ Shipping & Handling

For Q-Zone Queen **\$189.95**
+ Shipping & Handling

For Q-Zone Hoop-Frame **\$189.95**
+ Shipping & Handling

Cloth Leader by the Yard **\$22.95**
+ Shipping & Handling



WHAT ARE CLOTH LEADERS FOR?

Cloth leaders let you use less backing fabric and attach your quilt to your frame easily and accurately! The main job of the cloth leaders is to let your machine reach to the very beginning and end of your quilt when it's on the frame. Without leaders, the needle of your machine might not reach the beginning or end of your quilt when it's rolled on the frame.

NICE AND STRAIGHT

The Grace Company cloth leaders are printed with special lines that help you load your fabric to your frame straight and square. It's important to have a quilt that is square with the frame and not crooked.

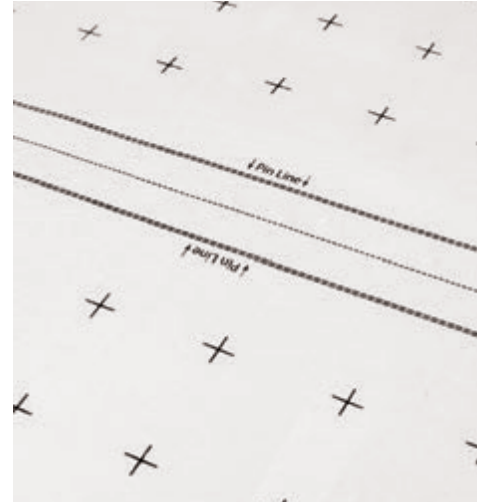

You can quilt on your frame without cloth leaders, but you'll need to make your backing material at least 12 inches longer than the rest of the quilt on the top edge, and 24 inches longer on the bottom edge.

QUILTING WITH CLOTH LEADERS

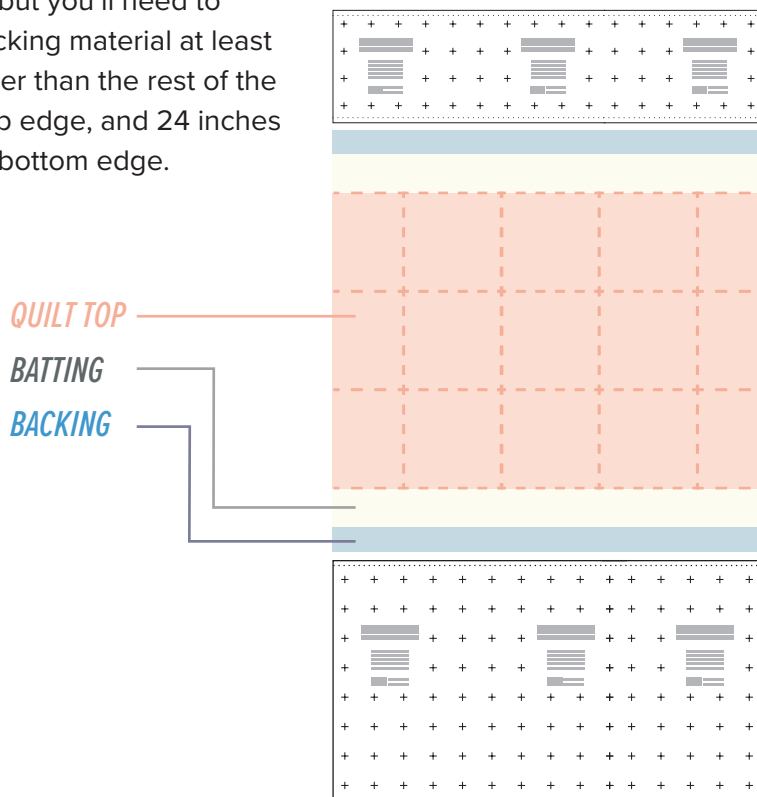

QUILTING WITHOUT CLOTH LEADERS

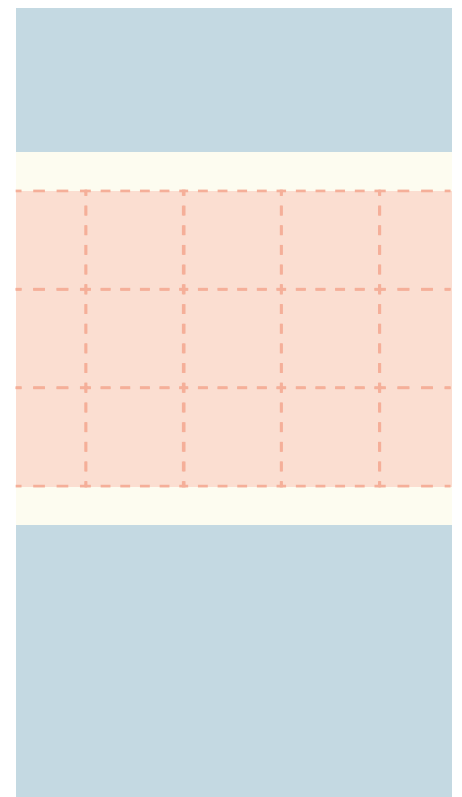

Finesse Quilting Thread

The quilters spoke, and The Grace Company listened. Introducing Finesse: the quilter's thread. Designed to work with both longarms and domestic machines, Finesse's strength and smooth finish eliminate tension issues. Quilters will love this soft, colorfast, and inexpensive thread—perfect for professionals and beginners alike.



FINESSE



50 WT/3 PLY
100% POLYESTER
1,500 YARDS



Variegated Colors
\$11.95

Solid Colors \$9.95

A NEED IN THE MARKET

Quilters often struggle to find quality longarm thread from their local shops. To help, Grace Company partnered with Wonderfil, a thread manufacturer known for their quality and attention to detail. Wonderfil custom manufactures Finesse thread exclusively for The Grace Company, and the results are a product that we are proud to share!

DURABLE

Finesse thread is 100% polyester and much stronger than cotton, making it durable but thin enough to prevent bulk while quilting.

VERSATILE

Thread is designed to glide smoothly in both domestic and longarm machines.





COLORFAST

Thread colors will not fade over time and the thread does not give off the artificial-looking shine that some polyester threads have.

QUILTER FRIENDLY

- Finesse's round design gives more depth to the stitch and will not lay flat
- It has low lint, which means less residue and less time cleaning the machine
- Finesse is also designed to make setting tension easy, and it won't break when stitching at a high velocity



EASY TO STORE

Save storage space by stacking your threads! Finesse mini-cones are stackable and small enough to fit into your sewing drawer.

THE PERFECT SIZE

The Finesse mini-cone is the perfect size balance between spool and cone, giving it just the right amount of yardage for one project. Quilters can feel free to try several of our beautiful colors without buying thread in unnecessarily large amounts.



Each color in the Finesse thread line was hand-chosen based on extensive research into the latest trends in design, fashion, and the quilting industry. The result was a beautiful collection of thread colors that we hope will inspire new waves of creativity in our quilters' next masterpieces.

SOLID COLORS



PREWOUND BOBBINS



VARIEGATED COLORS

2979
Rainbow

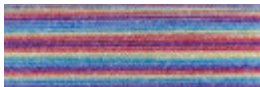

2980
Sunny Spring Day



2981
Strawberry Lemonade

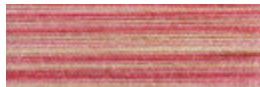

2982
Pastels

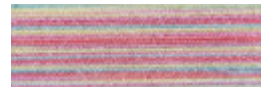

2983
Raspberry Ice



2986
Mauve Orchid



2987
Blueberries



2988
King of Atlantis



2990
Tropical Sunset



2991
Aurora Lights

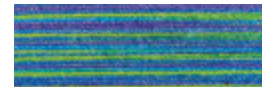

2994
Mountain Jungle

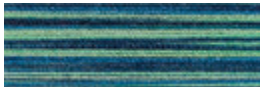

2995
Desert Flower

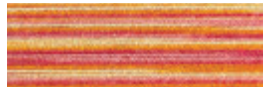

2996
Primary School

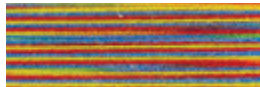

2997
Mojito

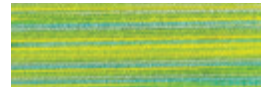

2998
Florence

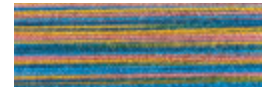

2999
Cherry Blossom



3000
Candy Apple



3001
Pomegranate



3002
Dusk Rose

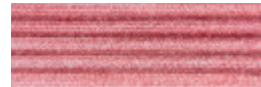

3003
Cotton Candy



3004
Tangerine Punch

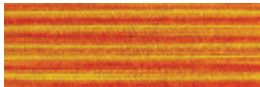

3005
Grapefruit



3006
Lemon Zest



3007
Light Spearmint



3008
Green Tea



3009
Deep Forest Green



3010
Vintage Turquoise



3011
Seaside Teal



3012
Ocean Wave



3013
Bright Blue Sky



3014
Lavender Blossom

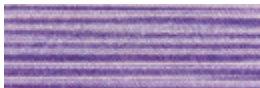

3015
Amethyst

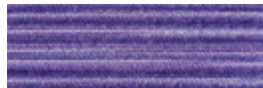

3016
Mountain Mist



3017
Riverbed Slate

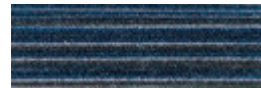

3018
Canyon Shale



TrueCut

TrueCut is a unique cutting system with features that provide the ultimate solution for common cutting frustrations. Every aspect of TrueCut has been designed to make rotary cutting **easier, safer and more accurate**.

SEE HOW IT WORKS!



<https://bit.ly/truecut-demo>

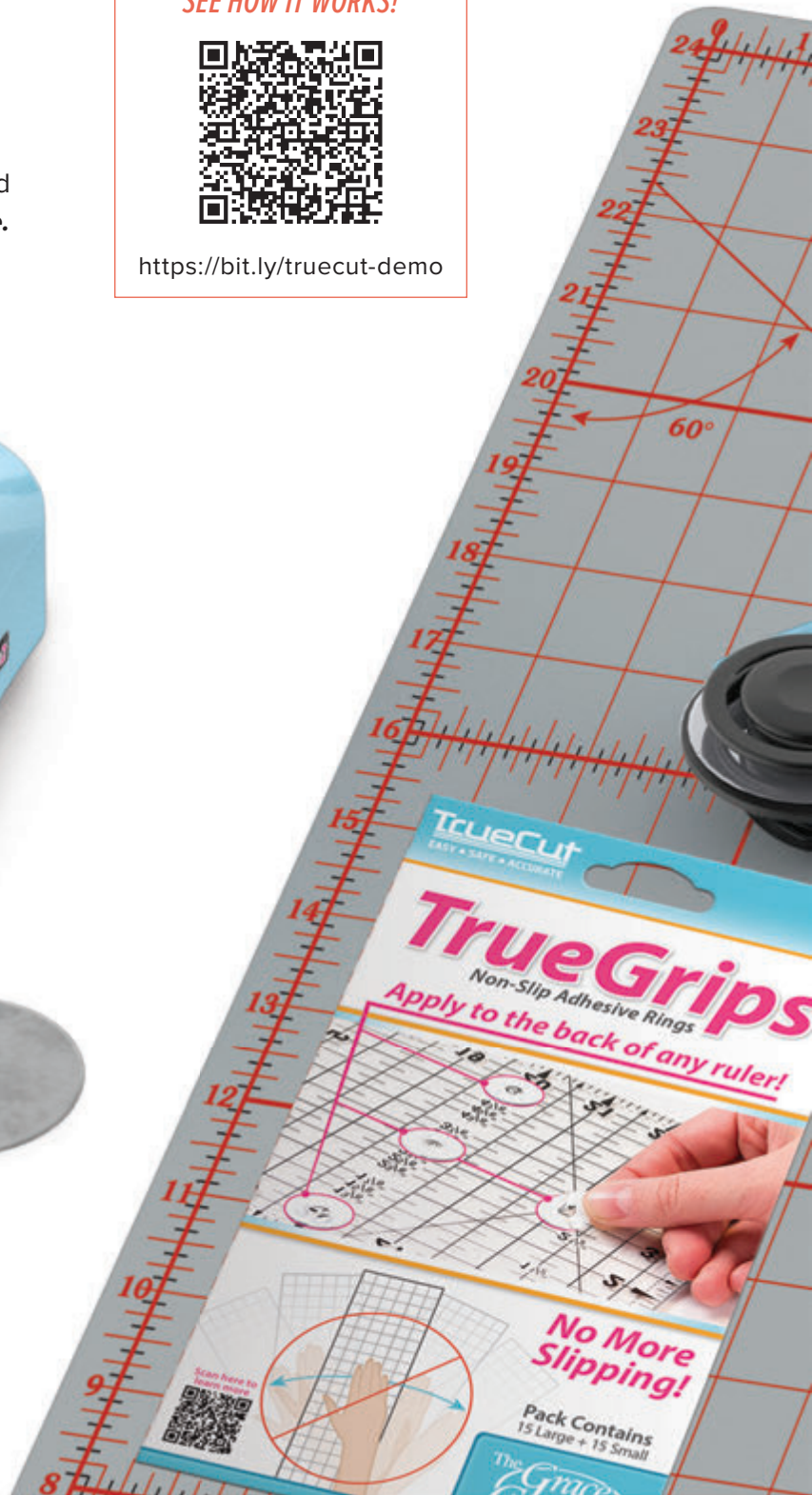

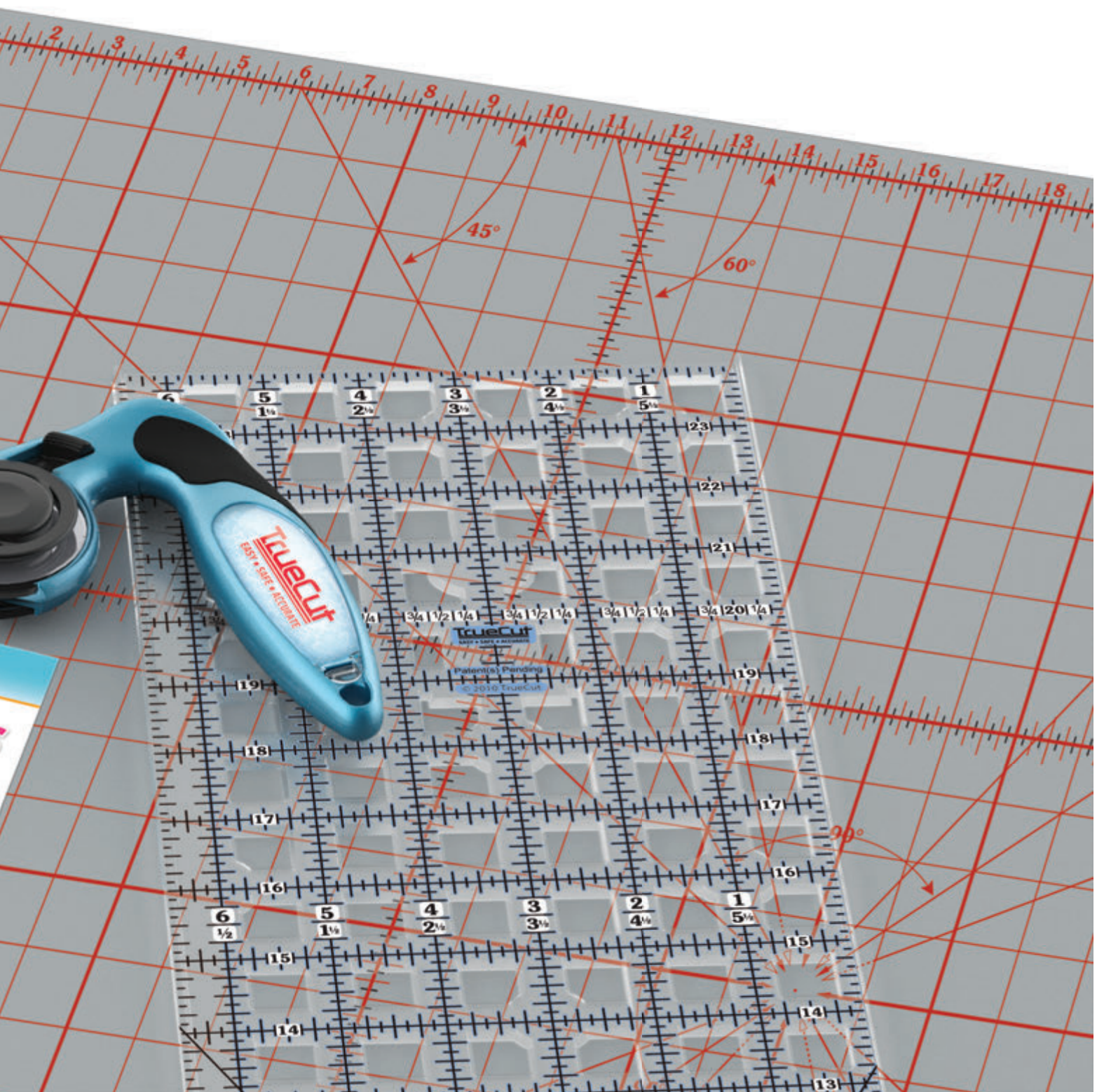

My Comfort Cutter

The My Comfort Cutter gives you more cutting power with less effort, thanks to its comfort curve grip! This ergonomic rotary cutter also includes the TrueCut Cutter Guide which works with our Ruler Track to give you superior precision and accuracy.

45MM WITH QUICK CHANGING BLADE

Quickly and safely change the blade with the push of a button!
(Currently only available on the 45mm)



WHAT OTHERS ARE SAYING

"Allows me to cut longer and more accurately. Thank you, Grace!"

—NANA'S THREADS

The comfort curve grip aligns your wrist naturally, placing all the cutting power directly over the blade and eliminating stress in the wrist and arm.

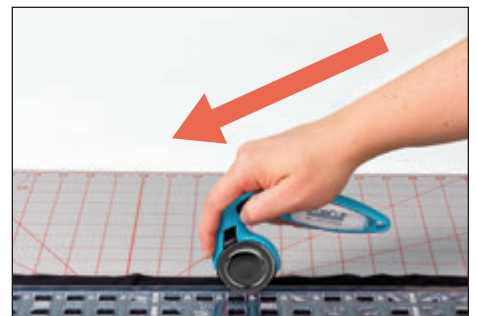
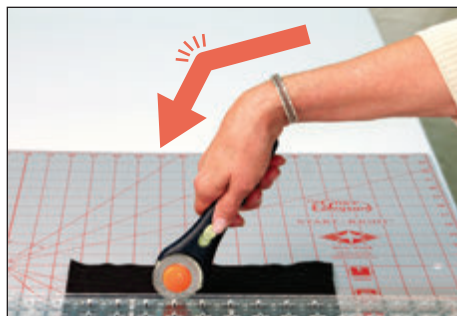

TRACK AND GUIDE SYSTEM

The TrueCut **Ruler Track** and **Cutter Guide** interlock to give you superior precision and accuracy! As you cut, the track and guide keep the cutter from slipping away from the ruler's edge.



My Comfort Cutter 60mm **\$39.95**

My Comfort Cutter 45mm **\$32.95**

My Comfort Cutter 28mm **\$24.95**



Larger blade for more cutting power; perfect for cutting multiple layers at once

FEATURES

- Comfort curve grip
- Cutter Guide works with Ruler Track
- Customizable handle inserts
- Available in 28mm, 45mm, or 60mm
- Works with most brands of blades
- Sets up for left or right-handed use
- Easy to use safety guard
- Removable cutter guide for normal use with non-TrueCut rulers



Standard blade; great for a variety of projects

CUSTOMIZE YOUR CUTTER'S HANDLE WITH YOUR OWN DESIGNS, PHOTOS OR FABRIC!



Smaller, more manageable blade—perfect for free-hand cutting curves and shapes

StraightCut Cutter

Our StraightCut rotary blade cutter features a straight style handle. It is available in three sizes, all of which will take rotary blades of most brands. The TrueCut Cutter Guide is also available on these cutters for use with the TrueCut Ruler Track. The Cutter Guide is removable for free-hand use, or use with rulers of other brands.

MAGNETIC QUICK CHANGING BLADE

Change blades with the push of a button!



Now with built-in magnets that make changing your blade easier and safer than ever before!



60mm \$37.95

45mm \$29.95

28mm \$23.95

A CUTTER FOR EVERY PROJECT

No matter what your project is, there is a rotary cutter for you. The 60mm cutter is for more power, or cutting multiple layers of fabric at once. The 45mm is a standard size cutter and great for just about any project. The 28mm cutter is perfect for more detailed free-style cutting or organic curves and shapes.

FEATURES

- Cutter Guide
- Safety guard
- Quick changing blades
- Takes most brands of blades
- Textured grip
- Left or right handed



TrueCut 360°

TrueCut 360° Circle Cutter \$57.90



SEE HOW IT WORKS!



<https://bit.ly/truecut360>

THE PERFECT CIRCLE CUTTING SOLUTION

Cutting curves and circles is a breeze with the TrueCut 360°! The innovative design makes it simple to use, and prevents the fabric from bunching or wrinkling as you cut.

ACCURATE, PRECISE CIRCLES

The TrueCut 360° is designed with exact markings for precise circles. Just set and lock in the circle size, and rotate the TrueCut 360° around the center for clean-cut, accurate circles.

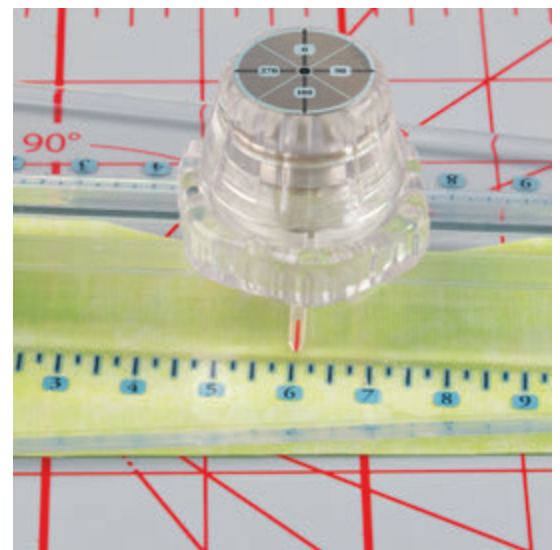

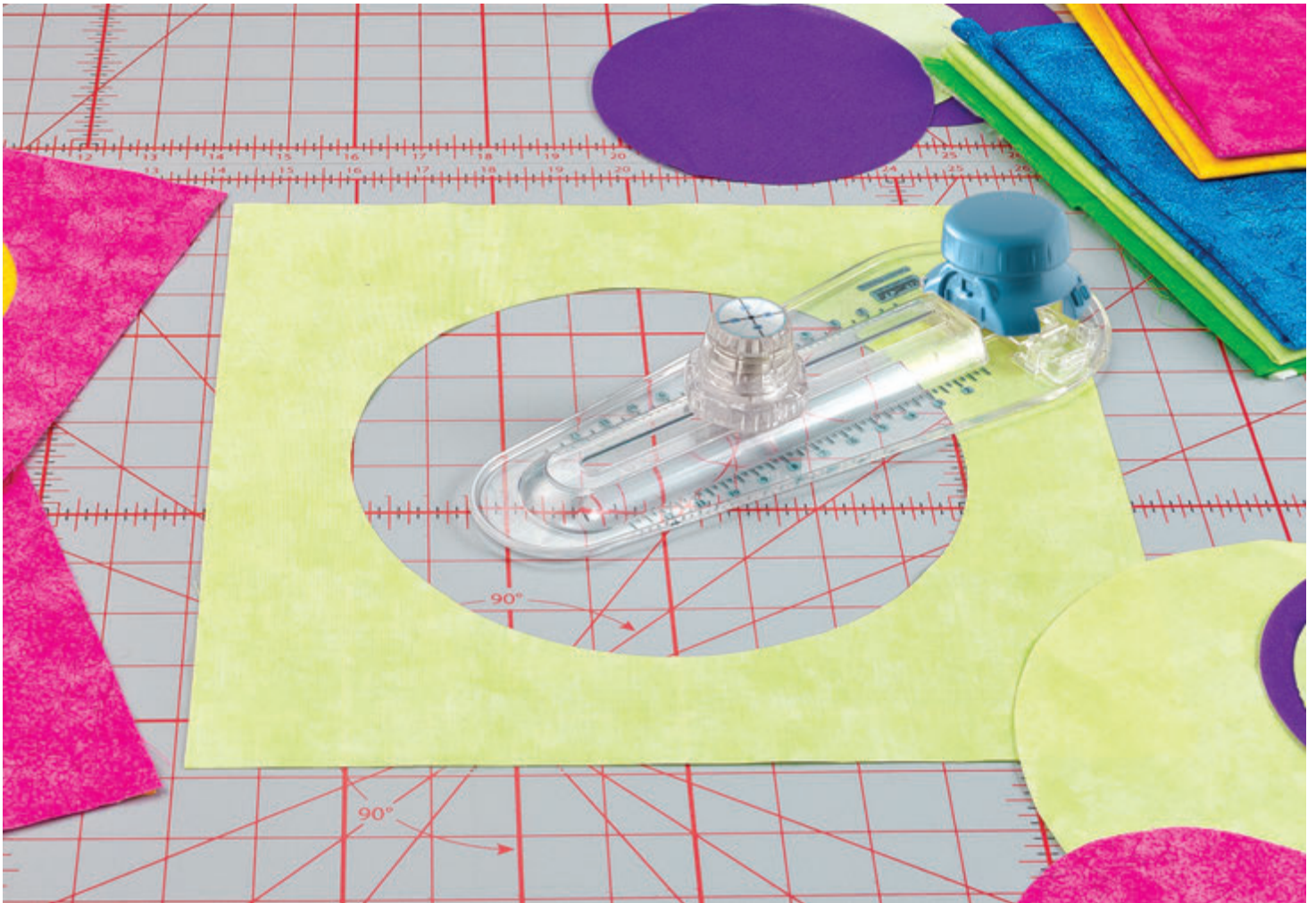

Extra Blade Cartridge **\$6.95**

FEATURES

- Precise ruler markings
- Locking center point
- No fabric bunching
- Clean-cut, accurate curves and circles

EXTRA BLADE CARTRIDGE

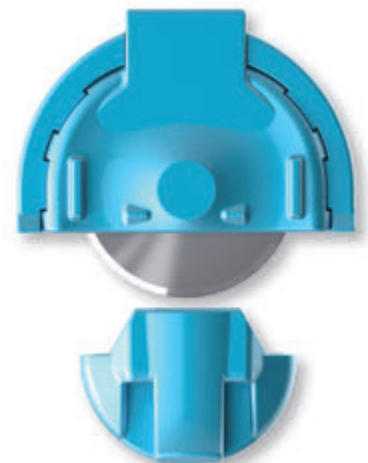

TrueCut Rulers

6.5 x 24.5 \$26.95

6.5 x 12.5 \$16.95

3 x 18 \$17.95

All TrueCut rulers come with the TrueCut Ruler Track. The guides on our cutters interlock with this raised edge, giving you straight and precise cuts. See the introduction for more details about the Ruler Track and Guide System.

FEATURES

These are traditional sized quilting rulers, perfect for cutting strips and just about any other project.

- Built-in Ruler Track
- Measurements in 1/8 inch increments
- Built-in marking holes
- Easy to see colors

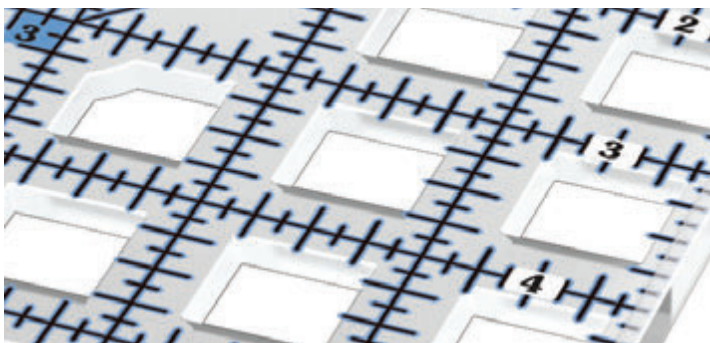
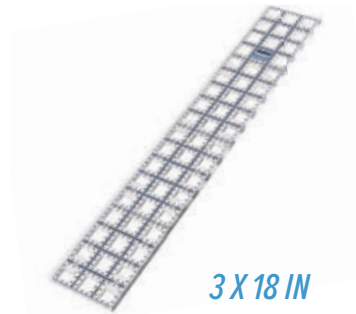
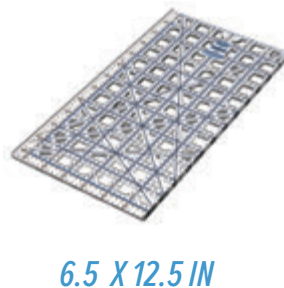

MARKING HOLES

Built-in holes are great for marking your fabric through your ruler! They also make holding down the ruler and fabric together easy for more stable cuts.

METRIC SIZES AVAILABLE

Check local dealers or call for prices: 1-800-264-0644.

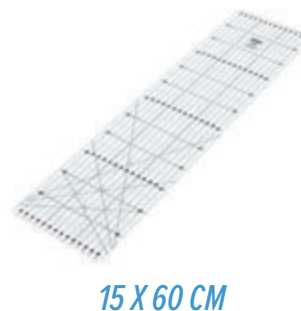

WHAT OTHERS ARE SAYING

"I have a TrueCut ruler and love it. I will be getting more."

—BRENDA T

SQUARE RULERS

Square rulers are great for precise measurements and ideal for squaring up blocks of fabric. These are also ideal for various shapes such as triangles. There are labeled inch marks along the 45 degree angle on these rulers, making them perfect for measuring and squaring up blocks.

12.5 x 12.5 **\$24.95**

9.5 x 9.5 **\$18.95**

6.5 x 6.5 **\$13.95**

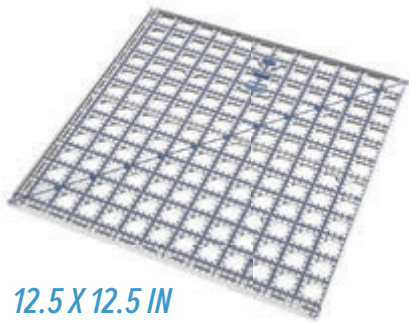

12.5 X 12.5 IN

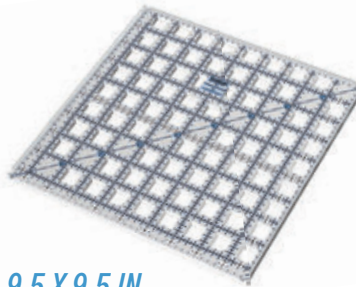

9.5 X 9.5 IN

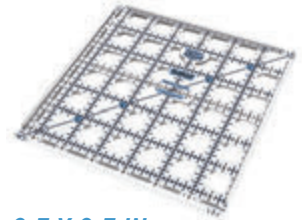

6.5 X 6.5 IN

TRIANGLE RULERS

Perfect for small shapes and pieces! The triangle rulers have specific angles to make cutting shapes a breeze. Each triangle ruler works with the patented TrueCut track and guide system, but can also be used with any other rotary cutter on the market.

60° Triangle Ruler **\$19.95**

60°, 90°, 120° Kite Ruler **\$19.95**

90° Right Angle Ruler **\$19.95**



60° TRIANGLE RULER



60°, 90°, 120° KITE RULER

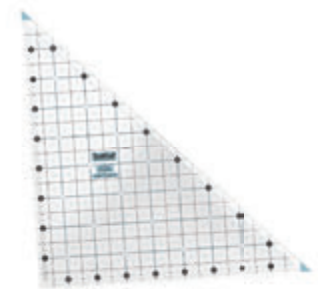

90° RIGHT ANGLE RULER

TrueSharp2

TrueSharp2 \$79.95

Stop wasting money on new blades! The TrueSharp 2 Power Sharpener sharpens your rotary blades with the push of a button! With its high quality sharpening stones, it sharpens **28mm**, **45mm**, and **60mm** blades.



KIT INCLUDES

- TrueSharp 2 Sharpener
- Power cord
- Set of fine, diamond grit stones
- Fine tuned motor speed
- Blade sharpening oil
- Blade handler
- Cleaning cloth
- Enhanced blade-holding design



*EVEN BETTER
SHARPENING RESULTS
IN FASTER TIME*

Linear Sharpener

Linear Rotary Blade Sharpener **\$39.95**

The linear sharpener extends the life of your blade! Sharpen your blade using the same motion you use to cut fabric! You don't even have to remove the blade from the cutter!



FEATURES

- Sharpens most brands of rotary blade from 28mm to 60mm
- Includes a high quality sharpening stone
- Nonslip bottom surface for safer sharpening while keeping hands clear of the blade



TrueCut Cutting Mats

36" x 24" \$74.95

24" x 18" \$49.95

18" x 12" \$24.95

TrueCut Cutting Mats are self-healing and double-sided for extended use. They include angle reference lines in easy-to-see colors, and have bias lines on the back.

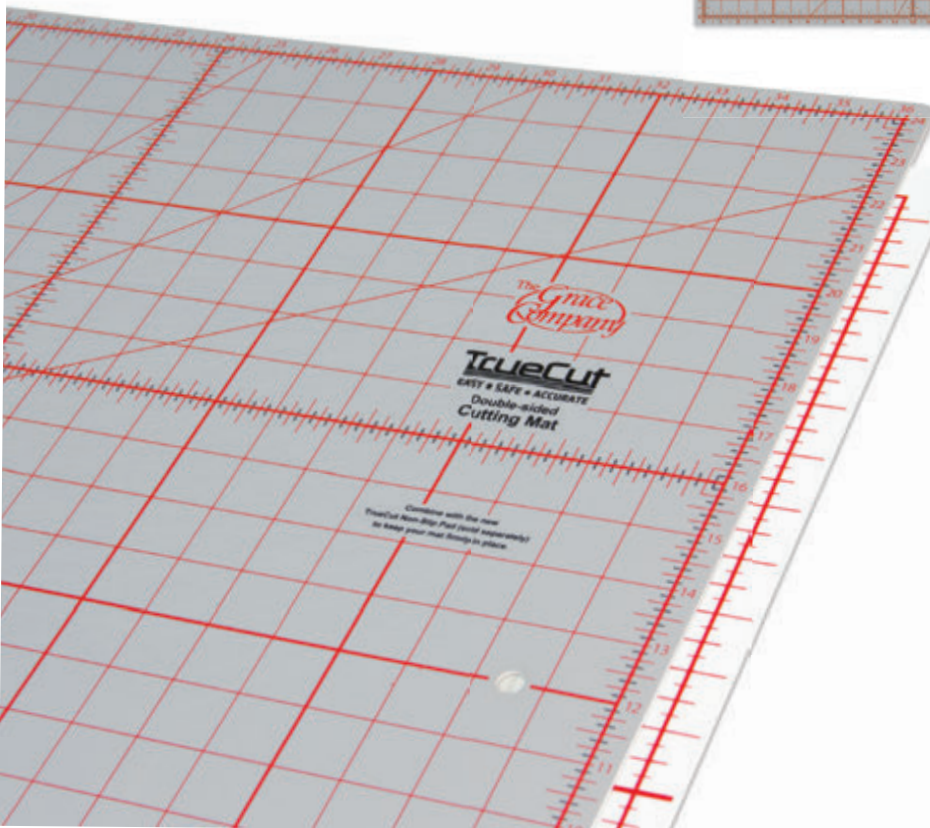
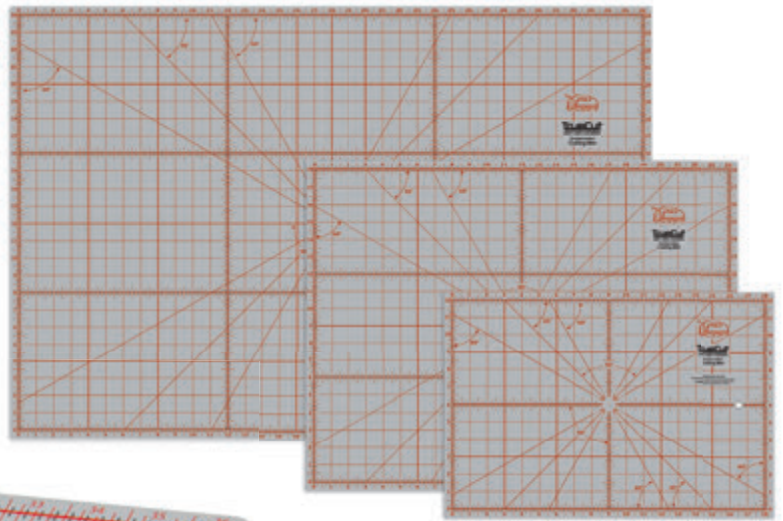

METRIC CUTTING MATS

Metric ruled cutting mats are also available. These are double sided, with inches on one side, and metric measurements on the other (with ½ centimeter increments)

Metric Cutting Mat 60 cm x 44 cm \$49.95

Metric Cutting Mat 90 cm x 60 cm \$74.95

TrueCut Non-Slip Pad

Non-Slip Pad **\$39.95**

The TrueCut Non-Slip Pad enhances both accuracy and safety. Place one underneath any cutting mat to hold it securely in place. They can be used on any surface to prevent sliding.

ONE SIZE

The TrueCut Non-Slip Pad now comes in one size that can be cut to different dimensions to fit your cutting mat. Cut along the lines indicated on the Non-Slip Pad to match your mat size.

FEATURES

- Stops cutting mats from slipping
- Enhances both accuracy and safety
- Use with any cutting mat

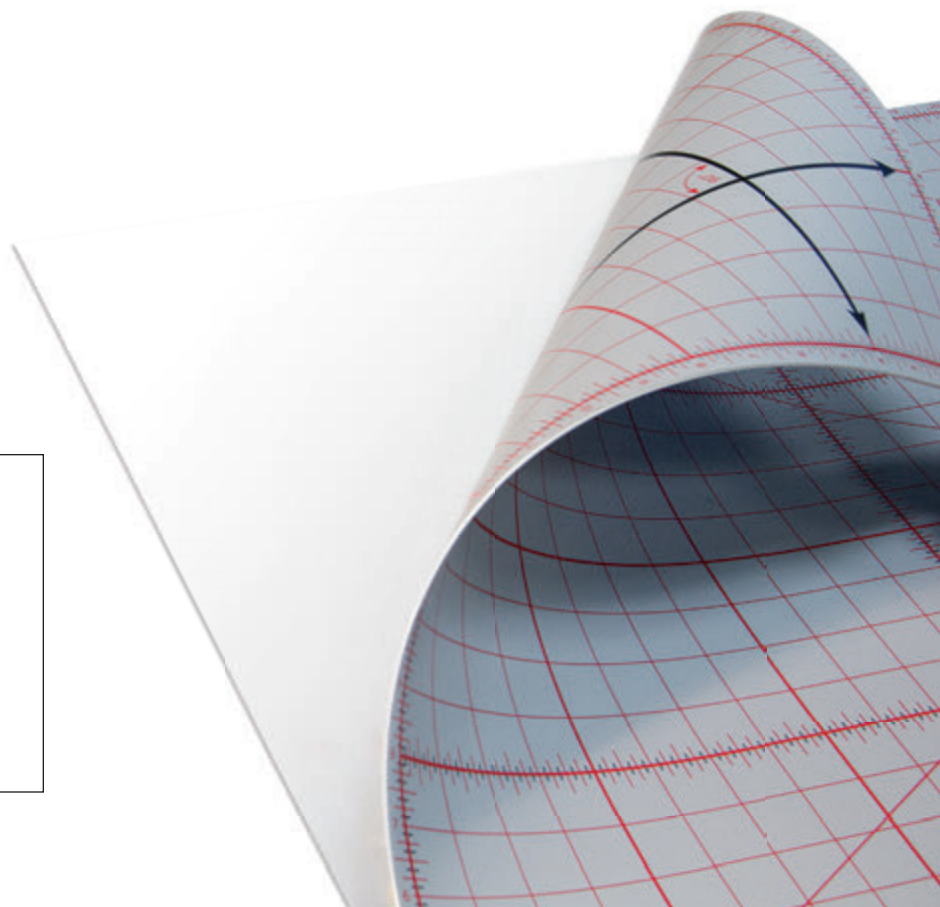
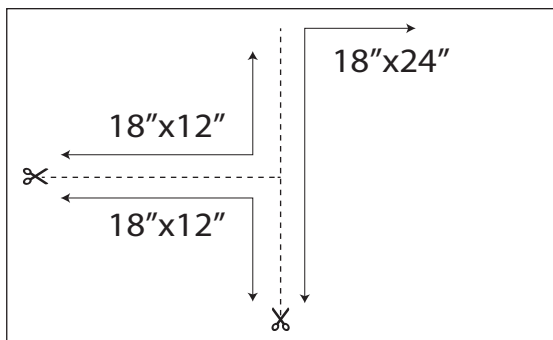

Travel Kit

TrueCut Travel Kit \$179.95

The carefully curated TrueCut Travel Kit includes everything you need to do what you love, all in one portable and stylish package. The tools and materials in this organized kit make it an essential for taking your craft with you on the go.



INCLUDED IN KIT

- Cutting Mat (8x10")
- Patchwork Board Kit
- StraightCut Cutter (28mm)
- Ruler (3x8")
- Seam Ripper
- Scissors
- Magnetic Wristband
- 50 Flower Pins
- TrueGrips
- Blue & White Marking Pencils
- #2 Pencil with Sharpener
- 3-Ring Organization Pouch

REMOVABLE ORGANIZER



PATCHWORK BOARD

This handy board provides a durable work surface for easy patterning, applique, and piecework.



TRAVEL SIZE CUTTING MAT

The perfect size for cutting fabric in your hotel room, on a long road trip, or while waiting at the airport.

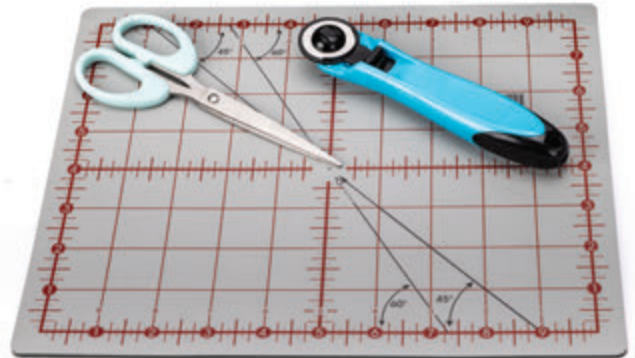

TWO DIFFERENT CARRY STYLES

This versatile Travel Kit is perfect for any occasion. Its stylish design will pair perfectly with your other accessories or luggage and match any outfit.



MAGNETIC PIN BRACELET

A convenient bracelet that keeps all your pins readily available.



TrueGrips

TrueGrips \$5.95

TrueGrips add a completely non-slip surface to any ruler.

- Comes in a pack of 15
- Transparent for easy fabric visibility
- Safeguards against slipping

WHAT OTHERS ARE SAYING

"I have the grips that stick onto my rulers, and it really helps a lot!"

—JONI C.



TrueGrips Hearts And Leaves

TrueGrips Hearts and Leaves \$10.95

Sue Pelland Designs
HEARTS & LEAVES

TrueGrips with convenient shapes to help mark key points on your ruler. Made to work especially well with select **Sue Pelland Designs** templates.

- 16 Big hearts and 24 small hearts
- 15 Big leaves and 15 small leaves

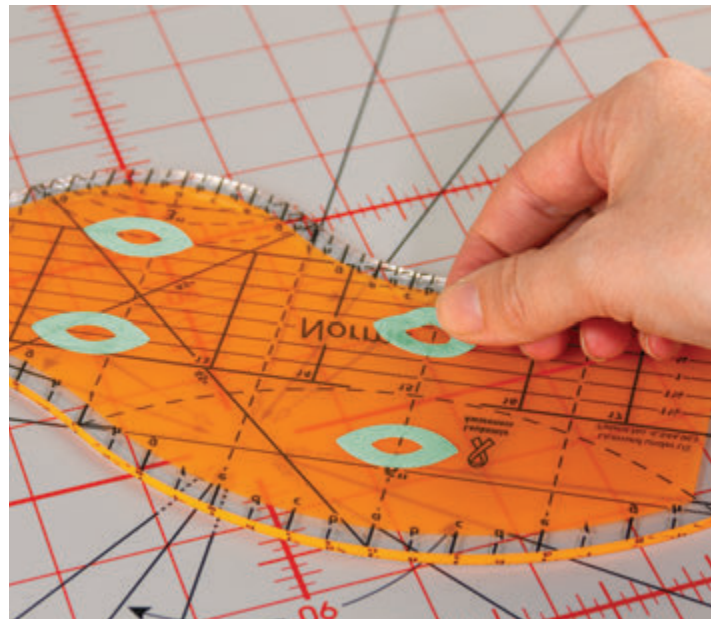

Rotary Blades

These blades are high quality SKS-7 stainless steel, to provide you with the sharpness and quality you've come to expect from a name like TrueCut. These blades are great in your TrueCut rotary cutters, but will also fit in most standard rotary cutters in the market!

45mm Single Pack **\$6.95**

45mm Double Pack **\$12.95**

45mm 5 Pack **\$29.95**

28mm Double Pack **\$7.95**

60mm single Pack **\$11.95**



Limited Warranty

The **Continuum II Frame, Q-Zone Queen, Q-Zone Hoop-Frame, Hoop-Frame Pro, Cutie Tabletop Fabric Frame, QuiltMotion Quilter's Creative Touch 5, Luminess LED Light Station**, and the **SureStitch Stitch Regulator** have a 1 year limited warranty.

We may, at our discretion, extend the warranty as circumstances dictate. Under this warranty, we will repair or replace, at our discretion, any part containing problems due to our manufacturing or defects in materials. This warranty does not cover parts damaged through misuse, improper storage, improper assembly, loss, natural events, or willful destruction. Parts must be returned to the Grace Company, shipping prepaid, before we can repair or replace them. We will promptly return the repaired/replaced part at our expense if the problem is brought to our attention within a year of the purchase date. After one year customers are responsible for the cost of return shipping.

Grace Products purchased from our dealers are subject to the dealer's refund policies. However, we stand behind our product warranties, whether purchased direct from us or any of our reputable dealers. We also handle all part replacement and technical support direct. Simply call us toll-free, for technical support and replacement parts needs.

For more warranty information, visit www.graceframe.com/en/page/warranty.

Note: *Product prices and shipping prices in this catalog are shown in U.S. dollars and are subject to change.*

Q'nique Warranty

The Grace Company guarantees these parts against manufacturing defects for the number of years of ownership listed below.

2-year limited warranty: Under the 2 Year Limited Warranty, Grace Company will at its discretion repair or replace any product with material or manufacturing defect. The customer is required to return the product to Grace Company. Upon receipt of the product, Grace Company will determine whether to repair or replace the defective product or part. The customer is responsible for any shipping costs required to get the product to or from the Grace Company. This warranty does not cover parts that are damaged through misuse, improper storage, improper assembly, loss, natural events, or willful destruction.

5-year/10-year limited warranty: Under the 5 Year Limited Warranty, The Grace Company will at its discretion repair or replace the cast metal body of the Q'nique Quilting Machines if not free of manufacturing defects or imperfections causing product failure. Parts must be sent to The Grace Company at customer's expense before The Grace Company will choose to replace them. This warranty does not cover parts that are damaged through misuse, improper storage, improper assembly, loss, natural events, or willful destruction. Those same parts on the **21X Elite or 19X Elite** are covered for **10 years**.

Warranty Exclusions: The warranty does not apply to any costs, repairs, or services for repairs necessitated by use other than normal home use, or damage resulting from misuse, abuse, accidents, alterations, or lack of proper machine maintenance.



Grace Products 30-Day Money-Back Guarantee

Grace Company strives for excellence in all we do. Any products purchased directly through The Grace Company are backed by our 30 Day Guarantee. This does not extend to purchases made through authorized dealers, who generally have their own return guarantee policy. If you are not satisfied within the first 30 days after purchase, The Grace Company will refund you the price of the product. Under the 30 Day Money-Back Guarantee the customer is responsible for all shipping costs. All products must be returned in new condition or the money-back guarantee is void. Proof of purchase will be required. All Grace Company products are eligible for this guarantee. The customer is responsible for all shipping costs under the money-back guarantee.

Quilts in catalog provided by: Sarah Matthews, Sue Higley, Karla Gerome, Sally Scott, and Laurel Verhaaren

Q'nique SureTrack, Start-Right, QuiltMotion, SureStitch, TrueCut, Plastic Pattern Perfect, and all other product names and Grace brands are trademarks of the The Grace Company. The Grace Company logo, the Q'nique logo, QuiltMotion logo and other product logos are trademarks or registered trademarks of the Grace Company. ©2020 The Grace Company.

Grace

COMPANY

MAILING ADDRESS

P.O. Box 27823
Salt Lake City, Utah 84127

PHYSICAL ADDRESS

2225 South 3200 West
West Valley City, Utah 84119

1-800-264-0644
www.graceframe.com

A \$9.95 US Dollar value.

